

JVC



COMPACT COMPONENT SYSTEM

KOMPAKT-KOMPONENTEN-SYSTEM

SYSTEME DE COMPOSANTS COMPACT

KOMPACTO KOMPONENTEN-SYSTEEM

SISTEMAS DE COMPONENTES COMPACTOS

IMPIANTO A COMPONENTI COMPATTO

CA-MXJ300

CA-MXJ200

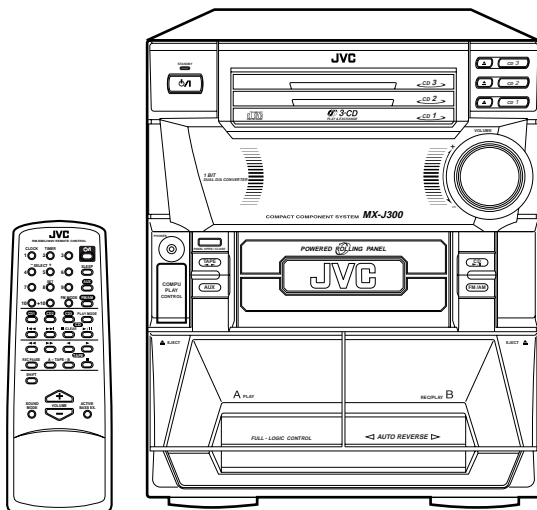

CA-MXJ300

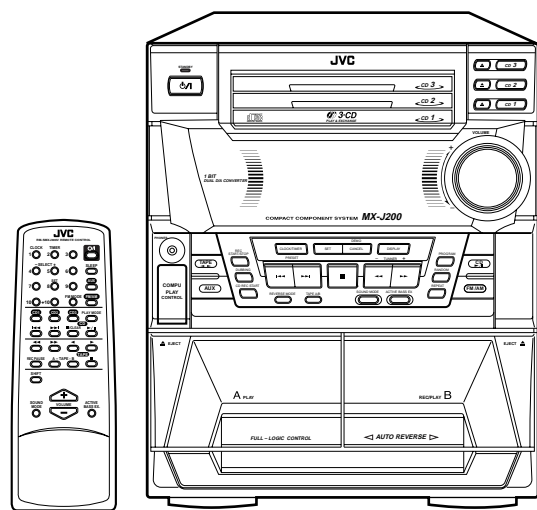

CA-MXJ200

COMPACT
disc
DIGITAL AUDIO

INSTRUCTIONS

BEDIENUNGSANLEITUNG

MANUEL D'INSTRUCTIONS

GEBRUIKSAANWIJZING

MANUAL DE INSTRUCCIONES

ISTRUZIONI

For Customer Use:

Enter below the Model No. and Serial No. which are located either on the rear, bottom or side of the cabinet. Retain this information for future reference.

Model No. _____

Serial No. _____

LVT0484-007B

[E]

Warnings, Cautions and Others / Warnung, Achtung und sonstige Hinweise / Mises en garde, précautions et indications diverses / Waarschuwingen, voorzorgen en andere mededelingen / Avisos, precauciones y otras notas / Avvertenze e precauzioni da osservare

IMPORTANT for the U.K.

DO NOT cut off the mains plug from this equipment. If the plug fitted is not suitable for the power points in your home or the cable is too short to reach a power point, then obtain an appropriate safety approved extension lead or consult your dealer.

BE SURE to replace the fuse only with an identical approved type, as originally fitted.

If nonetheless the mains plug is cut off ensure to remove the fuse and dispose of the plug immediately, to avoid a possible shock hazard by inadvertent connection to the mains supply.

If this product is not supplied fitted with a mains plug then follow the instructions given below:

IMPORTANT:

DO NOT make any connection to the terminal which is marked with the letter E or by the safety earth symbol or coloured green or green-and-yellow.

The wires in the mains lead on this product are coloured in accordance with the following code:

Blue : Neutral
Brown : Live

As these colours may not correspond with the coloured markings identifying the terminals in your plug proceed as follows:

The wire which is coloured blue must be connected to the terminal which is marked with the letter N or coloured black.

The wire which is coloured brown must be connected to the terminal which is marked with the letter L or coloured red.

IF IN DOUBT - CONSULT A COMPETENT ELECTRICIAN.

Per l'Italia:

"Si dichiara che il questo prodotto di marca JVC è conforme alle prescrizioni del Decreto Ministeriale n.548 del 28/08/95 pubblicato sulla Gazzetta Ufficiale della Repubblica Italiana n.301 del 28/12/95."

CAUTION

To reduce the risk of electrical shocks, fire, etc.:

1. Do not remove screws, covers or cabinet.
2. Do not expose this appliance to rain or moisture.

ACHTUNG

Zur Verhinderung von elektrischen Schlägen, Brandgefahr, usw.:

1. Keine Schrauben lösen oder Abdeckungen entfernen und das Gehäuse nicht öffnen.
2. Dieses Gerät weder Regen noch Feuchtigkeit aussetzen.

ATTENTION

Afin d'éviter tout risque d'électrocution, d'incendie, etc.:

1. Ne pas enlever les vis ni les panneaux et ne pas ouvrir le coffret de l'appareil.
2. Ne pas exposer l'appareil à la pluie ni à l'humidité.

VOORZICHTIG

Ter vermindering van gevaar voor brand, elektrische schokken, enz.:

1. Verwijder geen schroeven, panelen of de behuizing.
2. Stel het toestel niet bloot aan regen of vocht.

PRECAUCIÓN

Para reducir riesgos de choques eléctricos, incendio, etc.:

1. No extraiga los tornillos, las cubiertas ni la caja.
2. No exponga este aparato a la lluvia o a la humedad.

ATTENZIONE

Per ridurre il rischio di shock elettrici, incendi, ecc.:

1. Non togliete viti, coperchi o la scatola.
2. Non esponete l'apparecchio alla pioggia e all'umidità.

Caution — ⏻/! switch!

Disconnect the mains plug to shut the power off completely. The ⏻/! switch in any position does not disconnect the mains line. The power can be remote controlled.

Achtung — ⏻/!-Schalter!

Den Netzstecker aus der Steckdose ziehen, um die Stromversorgung vollkommen zu unterbrechen. Der Schalter ⏻/! unterbricht in keiner Stellung die Stromversorgung vollkommen. Die Stromversorgung kann mit der Fernbedienung ein- und ausgeschaltet werden.

Attention — Commutateur ⏻/!

Déconnecter la fiche de secteur pour couper complètement le courant. Le commutateur ⏻/! ne coupe jamais complètement la ligne de secteur, quelle que soit sa position. Le courant peut être télécommandé.

Voorzichtig — ⏻/! schakelaar!

Om de stroomtoevoer geheel uit te schakelen, trekt u de stekker uit het stopcontact. Anders zal er altijd een geringe hoeveelheid stroom naar het apparaat lopen, ongeacht de stand van de ⏻/! schakelaar. U kunt het apparaat ook met de afstandsbediening aan- en uitschakelen.

Precaución — Interruptor ⏻/!

Desconectar el cable de alimentación para desactivar la alimentación totalmente. Cualquiera que sea la posición de ajuste del interruptor ⏻/!, la alimentación no es cortada completamente. La alimentación puede ser controlada remotamente.

Attenzione — L'interruttore ⏻/!

Disinserire la spina del cavo di alimentazione dalla presa della rete elettrica per staccare completamente l'alimentazione. L'interruttore ⏻/! in nessuna posizione stacca la linea di alimentazione elettrica principale. È possibile il controllo remoto dell'alimentazione.

Caution: Proper Ventilation

To avoid risk of electric shock and fire, and to prevent damage, locate the apparatus as follows:

- 1 Front:
No obstructions and open spacing.
- 2 Sides/ Top/ Back:
No obstructions should be placed in the areas shown by the dimensions below.
- 3 Bottom:
Place on the level surface. Maintain an adequate air path for ventilation by placing on a stand with a height of 10 cm or more.

Achtung: Ausreichende Belüftung

Zur Vermeidung von elektrischen Schlägen, Feuer und sonstigen Schäden sollte das Gerät unter folgenden Bedingungen aufgestellt werden:

- 1 Vorderseite:
Hindernisfrei und gut zugänglich.
- 2 Seiten- und Rückwände:
Hindernisfrei in allen gegebenen Abständen (s. Abbildung).
- 3 Unterseite:
Die Stellfläche muß absolut eben sein. Sorgen Sie für ausreichende Luftzufuhr durch Aufstellung auf einem Stand mit mindestens 10 cm Höhe.

Attention: Aération correcte

Pour prévenir tout risque de décharge électrique ou d'incendie et éviter toute détérioration, installez l'appareil de la manière suivante:

- 1 Avant:
Bien dégagé de tout objet.
- 2 Côtés/dessus/dessous:
Assurez-vous que rien ne bloque les espaces indiqués sur le schéma ci-dessous.
- 3 Dessous:
Posez l'appareil sur une surface plane et horizontale. Veillez à ce que sa ventilation correcte puisse se faire en le plaçant sur un support d'au moins dix centimètres de hauteur.

Voorzichtig: Goede ventilatie vereist

Om brand, elektrische schokken en beschadiging te voorkomen, moet u het toestel als volgt opstellen:

- 1 Voorkant:
Geen belemmeringen en voldoende ruimte.
- 2 Zijkanten/boven-/onderkant:
Geen belemmeringen plaatsen in de hieronder aangegeven zones.
- 3 Onderkant:
Op vlakke ondergrond plaatsen. Voldoende ventilatieruimte voorzien door het toestel op een onderstel met een hoogte van 10 cm of meer te plaatsen.

Precaución: ventilación correcta

Para evitar el riesgo de descargas eléctricas e incendio y prevenir posibles daños, instale el equipo en un lugar que cumpla los siguientes requisitos:

- 1 Parte frontal:
Sin obstrucciones, espacio abierto.
- 2 Lados/parte superior/parte posterior:
No debe haber ninguna obstrucción en las áreas mostradas por las dimensiones de la siguiente figura.
- 3 Parte inferior:
Sitúe el equipo sobre una superficie nivelada. Mantenga un espacio adecuado para permitir el paso del aire y una correcta ventilación, situando el equipo sobre un soporte de 10 o más cm de altura.

Attenzione: Per una corretta ventilazione

Per prevenire il rischio di scosse elettriche e di incendio ed evitare possibili danni, collocare le apparecchiature nel modo seguente:

- 1 Parte anteriore:
Nessun ostacolo e spazio libero.
- 2 Lati/Parte superiore/Retro:
Lasciare libere le zone indicate dalle dimensioni di seguito.
- 3 Base:
Collocare su una superficie piana. Consentire un'adeguata ventilazione dell'impianto appoggiandolo su un tavolino alto almeno 10 cm.

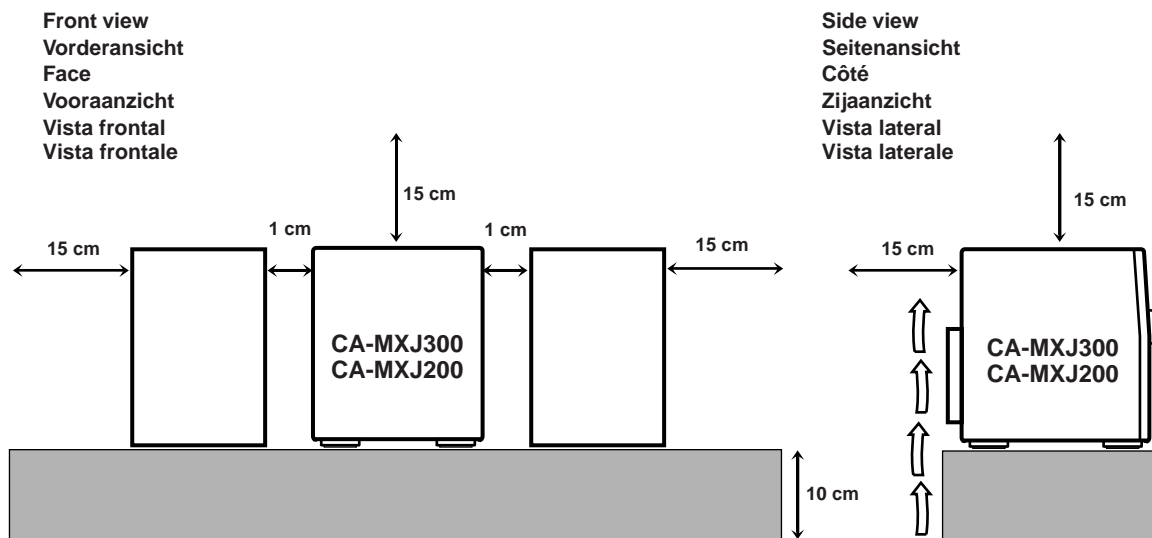

IMPORTANT FOR LASER PRODUCTS / WICHTIGER HINWEIS FÜR LASER-PRODUKTE / IMPORTANT POUR LES PRODUITS LASER / BELANGRIJKE INFORMATIE VOOR LASERPRODUKTEN / IMPORTANTE PARA LOS PRODUCTOS LÁSER / IMPORTANTE PER I PRODOTTI LASER

REPRODUCTION OF LABELS/ANBRINGUNGSORTE FÜR LASER-PRODUKTE/REPRODUCTION DES ETIQUETTES/VERKLARING VAN DE LABELS/REPRODUCCIÓN DE ETIQUETAS/RIPRODUZIONE DELLE ETICHETTE

- | | |
|--|---|
| ① CLASSIFICATION LABEL, PLACED ON REAR ENCLOSURE | ② WARNING LABEL, PLACED INSIDE THE UNIT |
| ① KLASSIFIKATIONSETIKETTE AN DER RÜCKSEITE | ② WARNETIKETTE IM GERÄTEINNEREN |
| ① ETIQUETTE DE CLASSIFICATION, PLACÉE A L'ARRIÈRE DU COFFRET | ② ETIQUETTE D'AVERTISSEMENT PLACÉE À L'INTERIEUR DE L'APPAREIL |
| ① KLASSIFIKATIELABEL, OP DE ACHTERZIJDE VAN HET APPARAAT | ② WAARSCHUWINGSLABEL, IN HET APPARAAT |
| ① ETIQUETA DE CLASIFICACIÓN, PEGADA EN LA PARTE POSTERIOR DE LA CAJA | ② ETIQUETA DE ADVERTENCIA, PEGADA EN EL INTERIOR DE LA UNIDAD |
| ① ETICHETTA DI CLASSIFICAZIONE, SITUATA SUL RIVESTIMENTO POSTERIORE | ② ETICHETTA DI AVVERTENZA, SITUATA ALL'INTERNO DELL'APPARECCHIO |

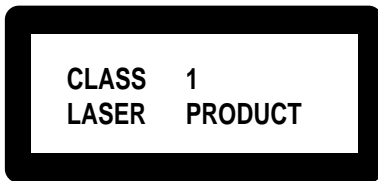

DANGER: Invisible laser radiation when open and interlock failed or defeated. AVOID DIRECT EXPOSURE TO BEAM. (e)	WARNING: Osynlig laserstrålning när denna del är öppnad och spärren är urkopplad. Betrakta ej strålen. (s)	ADVARSEL: Usynlig laserstrålning ved åbning, når sikkerhedsafbrydere er ude af funktion. Undgå udsættelse for stråling (d)	VARO: Avattaessa ja suojalukitus ohitettaessa olet alttiina näkymättömälle lasersäteilylle. Älä katso säteeseen. (f)
---	---	---	---

- | | |
|---|---|
| <ol style="list-style-type: none">1. CLASS 1 LASER PRODUCT2. DANGER: Invisible laser radiation when open and interlock failed or defeated. Avoid direct exposure to beam.3. CAUTION: Do not open the top cover. There are no user serviceable parts inside the Unit; leave all servicing to qualified service personnel. | <ol style="list-style-type: none">1. KLAS 1 LASERPRODUKT2. GEVAARLIJK: Onzichtbare laserstraling wanneer open en de beveiliging faalt of uitgeschakeld is. Voorkom het direct blootstaan aan de straal.3. VOORZICHTIG: De bovenkap niet openen. Binnenin het toestel bevinden zich geen door de gebruiker te repareren onderdelen: laat onderhoud over aan bekwame vakpersoneel. |
| <ol style="list-style-type: none">1. LASER-PRODUKT DER KLASSE 12. GEFAHR: Unsichtbare Laserstrahlung bei Öffnung und fehlerhafter oder beschädigter Spre. Direkten Kontakt mit dem Strahl vermeiden!3. ACHTUNG: Das Gehäuse nicht öffnen. Das Gerät enthält keinerlei Teile, die vom Benutzer gewartet werden können. Überlassen Sie Wartungsarbeiten bitte qualifizierten Kundendienst-Fachleuten. | <ol style="list-style-type: none">1. PRODUCTO LASER CLASE 12. PELIGRO: En el interior hay radiación láser invisible. Evite el contacto directo con el haz.3. PRECAUCIÓN: No abra la tapa superior. En el interior de la unidad no existen piezas reparables por el usuario; deje todo servicio técnico en manos de personal calificado. |
| <ol style="list-style-type: none">1. PRODUIT LASER CLASSE 12. ATTENTION: Radiation laser invisible quand l'appareil est ouvert ou que le verrouillage est en panne ou désactivé. Eviter une exposition directe au rayon.3. ATTENTION: Ne pas ouvrir le couvercle du dessus. Il n'y a aucune pièce utilisable à l'intérieur. Laisser à un personnel qualifié le soin de réparer votre appareil. | <ol style="list-style-type: none">1. PRODOTTO LASER CLASSE 12. PERICOLO: Radiazione laser invisibile quando l'apparecchio è aperto ed il dispositivo di sicurezza è guasto o disattivato. Evitare l'esposizione diretta ai raggi.3. ATTENZIONE: Non aprire il coperchio superiore. Non vi sono parti adoperabili dall'utente all'interno di questo apparecchio; lasciare tutti i controlli a personale qualificato. |

Introduction

We would like to thank you for purchasing one of our JVC products. Before operating this unit, read this manual carefully and thoroughly to obtain the best possible performance from your unit, and retain this manual for future reference.

About This Manual

This manual is organized as follows:

- The manual mainly explains operations using the buttons and controls on the unit. You can also use the buttons on the remote control if they have the same or similar names (or marks) as those on the unit. If operation using the remote control is different from that using the unit, it is then explained.
- The illustrations used in this manual are of CA-MXJ300.
- Basic and common information that is the same for many functions is grouped in one place, and is not repeated in each procedure. For instance, we do not repeat the information about turning on/off the unit, setting the volume, changing the sound effects, and others, which are explained in the section “Common Operations” on pages 11 to 13.
- The following marks are used in this manual:



Gives you warnings and cautions to prevent from a damage or risk of fire/electric shock. Also gives you information which is not good for obtaining the best possible performance from the unit.



Gives you information and hints you had better know.

Precautions

Installation

- Install in a place which is level, dry and neither too hot nor too cold — between 5°C (41°F) and 35°C (95°F).
- Install the unit in a location with adequate ventilation to prevent internal heat built-up in the unit.
- Leave sufficient distance between the unit and the TV.
- Keep the speakers away from the TV to avoid interference with TV.



DO NOT install the unit in a location near heat sources, or in a place subject to direct sunlight, excessive dust or vibration.

Power sources

- When unplugging from the wall outlet, always pull the plug, not the AC power cord.



DO NOT handle the AC power cord with wet hands.

Moisture condensation

Moisture may condense on the lens inside the unit in the following cases:

- After starting heating in the room
 - In a damp room
 - If the unit is brought directly from a cold to a warm place
- Should this occur, the unit may malfunction. In this case, leave the unit turned on for a few hours until the moisture evaporates, unplug the AC power cord, and then plug it in again.

Others

- Should any metallic object or liquid fall into the unit, unplug the unit and consult your dealer before operating any further.
- If you are not going to operate the unit for an extended period of time, unplug the AC power cord from the wall outlet.



DO NOT disassemble the unit since there are no user serviceable parts inside.

If anything goes wrong, unplug the AC power cord and consult your dealer.

Location of the Buttons and Controls	3
CA-MXJ300 Front Panel	4
CA-MXJ200 Front Panel	6
Remote Control	7
Getting Started	8
Unpacking	8
Putting the Batteries into the Remote Control	8
Connecting Antennas	8
Connecting Speakers	9
Connecting Other Equipment	10
Common Operations	11
Setting the Clock	11
Turning On the Power and Selecting the Sources	12
Adjusting the Volume	12
Reinforcing the Bass Sound	13
Selecting the Sound Modes	13
Listening to FM and AM (MW/LW) Broadcasts ...	14
Tuning in a Station	14
Presetting Stations	14
Tuning in a Preset Station	14
Playing Back CDs	15
Loading CDs	15
Playing Back the Entire Discs	
— Continuous Play	15
Basic CD Operations	15
Programming the Playing Order of the Tracks	
— Program Play	16
Playing at Random — Random Play	17
Repeating Tracks or CDs — Repeat Play	18
Prohibiting Disc Ejection — Tray Lock	18
Playing Back Tapes	19
Playing Back a Tape	19
Recording	20
Recording Tapes on Deck B	20
Dubbing Tapes	21
CD Direct Recording	21
Using the Timers	22
Using Daily Timer	22
Using Recording Timer	24
Using Sleep Timer	26
Timer Priority	26
Maintenance	27
Troubleshooting	28
Specifications	28

Location of the Buttons and Controls

CA-MXJ300

Become familiar with the buttons and controls on your unit.

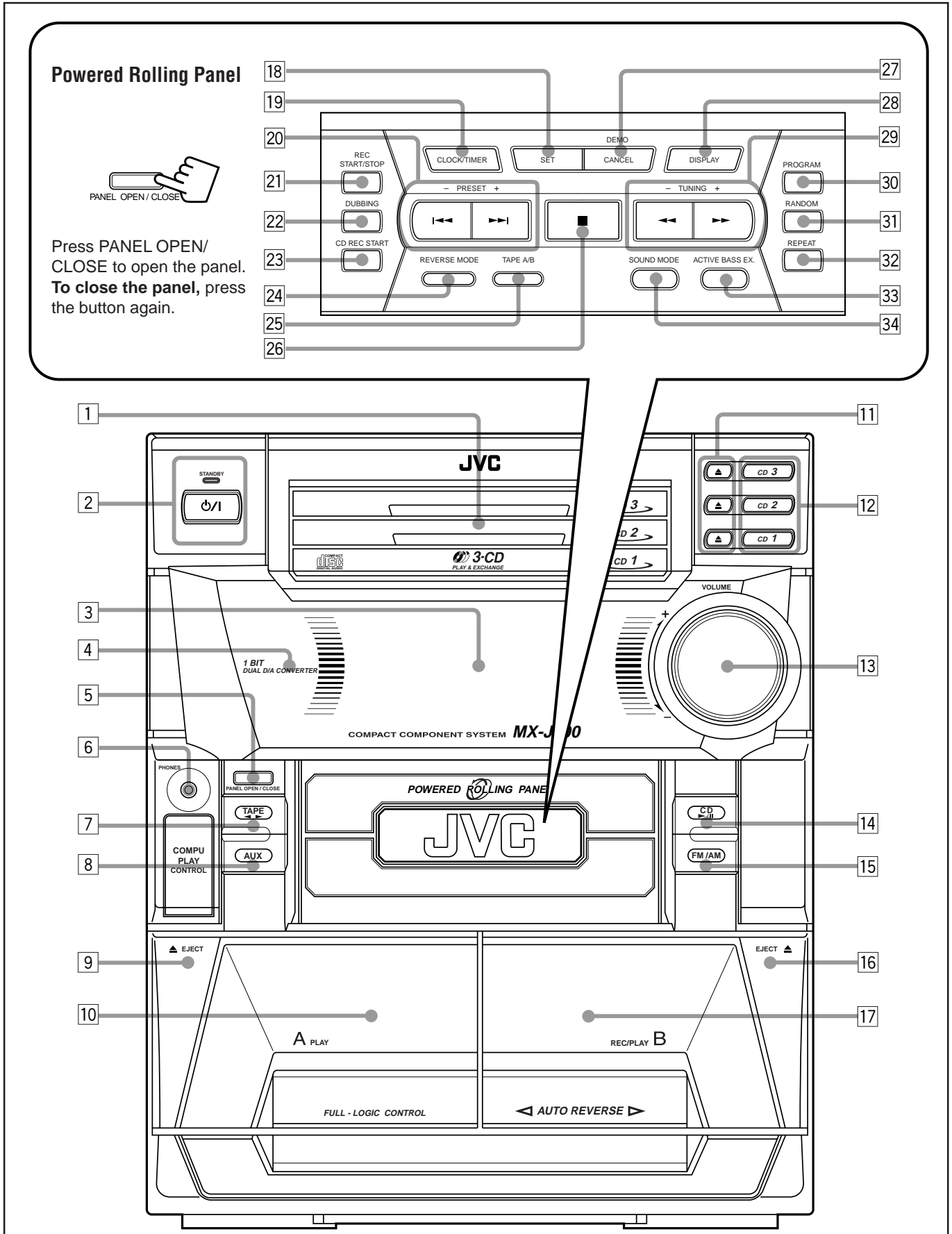

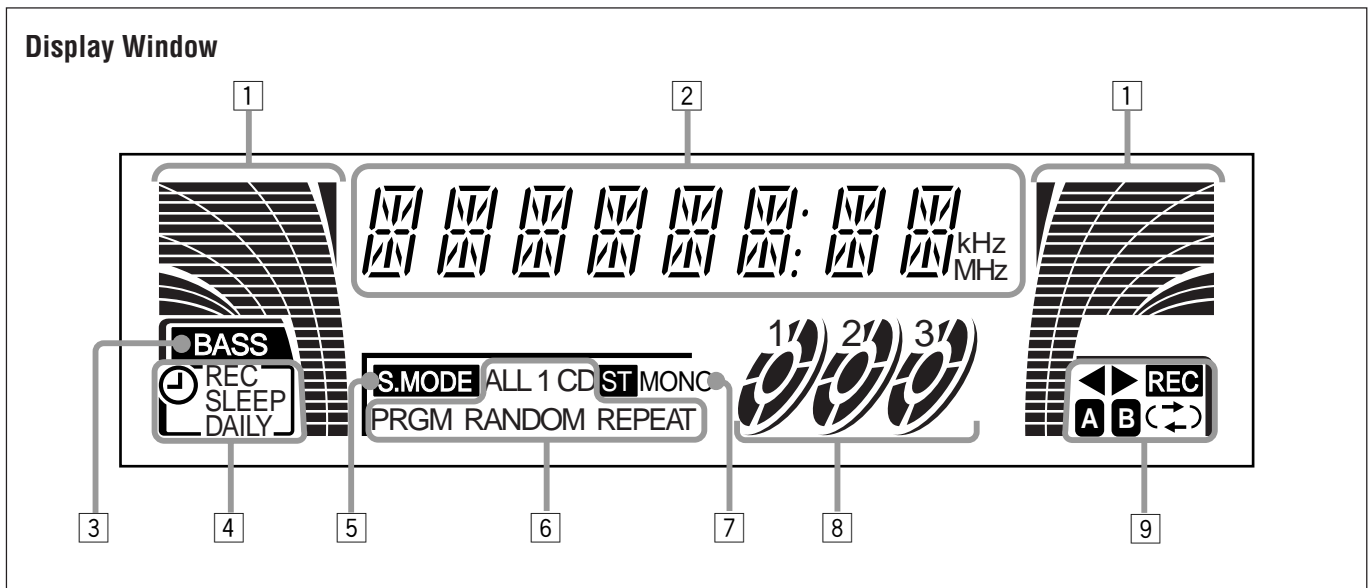

See pages in the parentheses for details.

CA-MXJ300 Front Panel

- 1 Disc trays
- 2 \mathcal{O}/I (standby/on) button and STANDBY lamp (12)
- 3 Display window
- 4 Remote sensor
- 5 PANEL OPEN/CLOSE button (11)
Pressing this button also turns on the unit.
- 6 PHONES jack (12)
- 7 TAPE $\blacktriangleleft/\blacktriangleright$ button and lamp (19)
Pressing this button also turns on the unit.
- 8 AUX button and lamp (12)
Pressing this button also turns on the unit.
- 9 \blacktriangle EJECT button for deck A (19)
- 10 Deck A cassette holder (19)
- 11 \blacktriangle (CD tray open/close) buttons (15)
Pressing one of these buttons also turns on the unit.
- 12 Disc number buttons (CD 1, CD 2, and CD 3) (15, 16, 21)
Pressing one of these buttons also turns on the unit.
- 13 VOLUME control (12)
- 14 CD $\blacktriangleright/\text{II}$ (play/pause) button and lamp (15)
Pressing this button also turns on the unit.
- 15 FM/AM button and lamp (14)
Pressing this button also turns on the unit.
- 16 EJECT \blacktriangle button for deck B (19)
- 17 Deck B cassette holder (19)
- 22 DUBBING button (21)
- 23 CD REC START button (21)
- 24 REVERSE MODE button (19, 21)
- 25 TAPE A/B button (19)
- 26 \blacksquare (stop) button (15, 19)
- 27 CANCEL button (11, 17, 23)
DEMO button (10)
- 28 DISPLAY button (11)
- 29 TUNING $- / +$ buttons (14)
These buttons do not function as $\blacktriangleleft / \blacktriangleright$.
- 30 PROGRAM button (16, 21)
- 31 RANDOM button (17)
- 32 REPEAT button (18)
- 33 ACTIVE BASS EX. (extension) button and lamp (13)
- 34 SOUND MODE button (13)

Display window

- 1 Audio level indicator
- 2 Main display
 - Shows the source name, frequency, etc.
- 3 BASS (active bass extension) indicator
- 4 Timer indicators
 - \mathcal{O} , REC, SLEEP, and DAILY indicators
- 5 S.MODE indicator
- 6 CD play mode indicators
 - PRGM (program), RANDOM and REPEAT (ALL/1CD/1) indicators
- 7 Tuner operation indicators
 - ST (stereo) and MONO indicators
- 8 Disc indicators
- 9 Tape operation indicators
 - $\blacktriangleleft / \blacktriangleright$ (tape direction), REC, A/B (operating deck) and $\blacktriangleleft / \blacktriangleright$ (reverse mode) indicators

Powered Rolling Panel

- 18 SET button (11, 22)
- 19 CLOCK/TIMER button (11, 22)
- 20 PRESET $- / +$ buttons (14)
 $\blacktriangleleft / \blacktriangleright$ (reverse search/forward search) buttons (11, 16, 22)
 $\blacktriangleleft / \blacktriangleright$ (fast left/fast right) buttons (19)
- 21 REC START/STOP button (20)

CA-MXJ200

Become familiar with the buttons and controls on your unit.

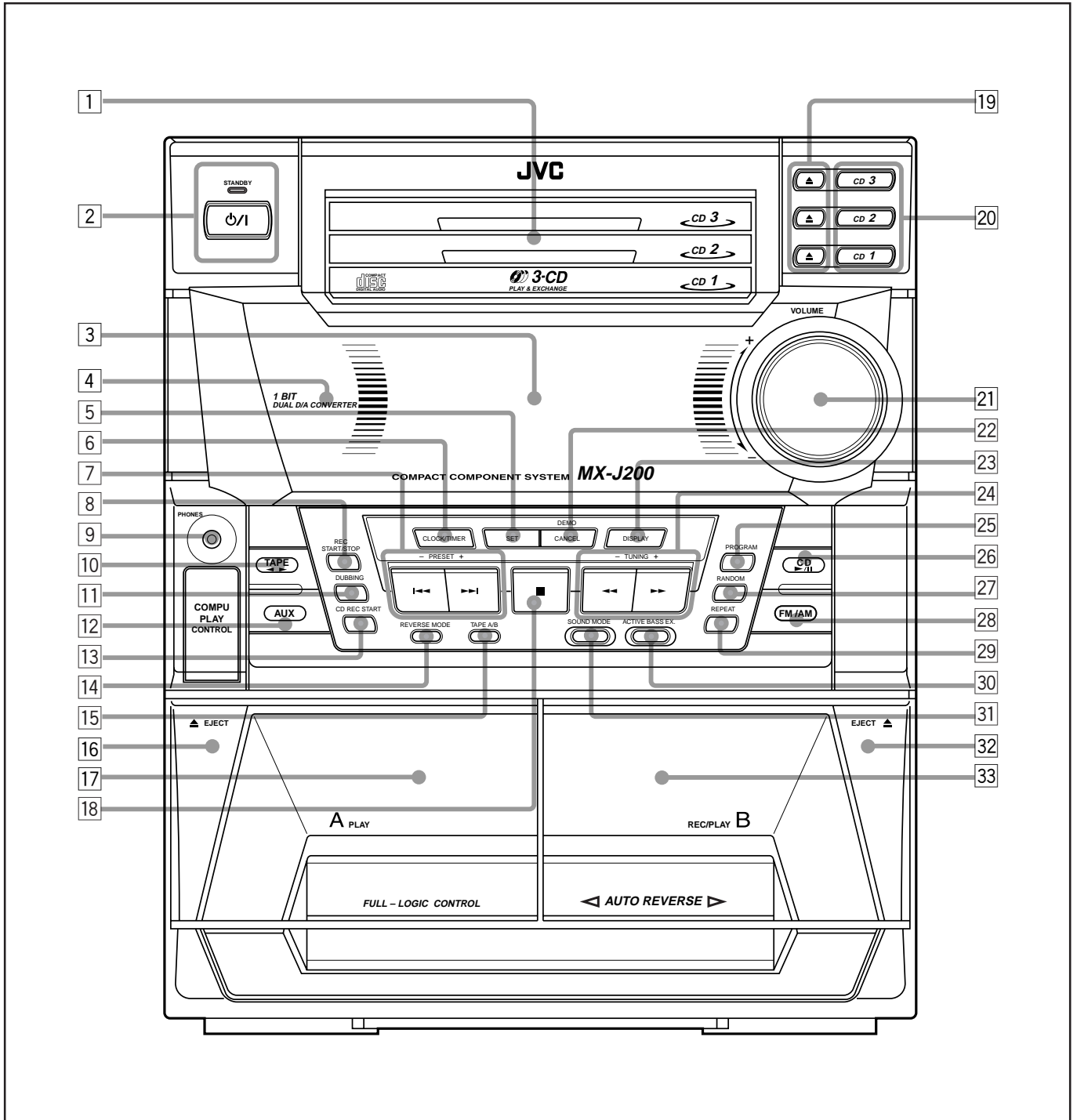

Display Window

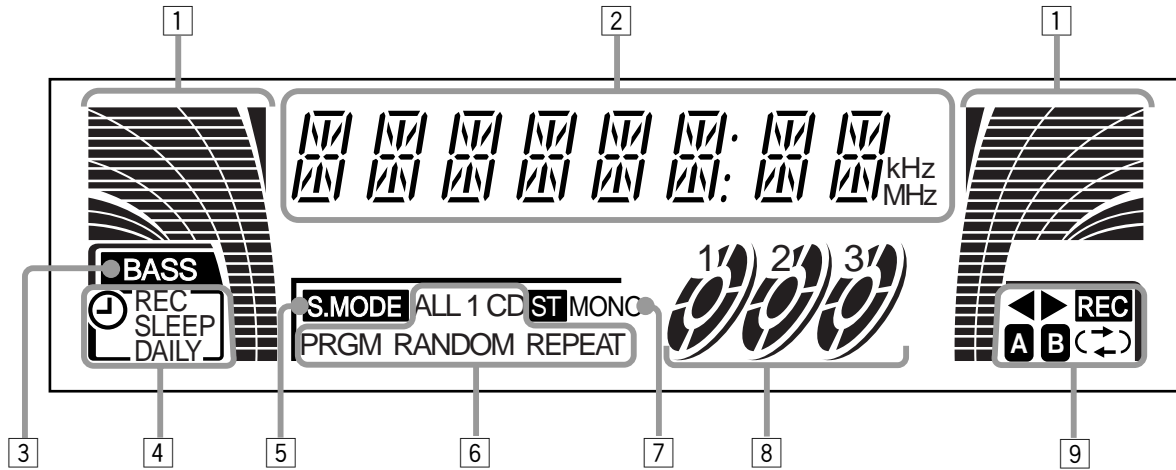

See pages in the parentheses for details.

CA-MXJ200 Front Panel

- 1 Disc trays
- 2 (standby/on) button and STANDBY lamp (12)
- 3 Display window
- 4 Remote sensor
- 5 SET button (11, 22)
- 6 CLOCK/TIMER button (11, 22)
- 7 PRESET - / + buttons (14)
 / (reverse search/forward search) buttons (11, 16, 22)
 / (fast left/fast right) buttons (19)
- 8 REC START/STOP button (20)
- 9 PHONES jack (12)
- 10 TAPE button and lamp (19)
Pressing this button also turns on the unit.
- 11 DUBBING button (21)
- 12 AUX button and lamp (12)
Pressing this button also turns on the unit.
- 13 CD REC START button (21)
- 14 REVERSE MODE button (19, 21)
- 15 TAPE A/B button (19)
- 16 EJECT button for deck A (19)
- 17 Deck A cassette holder (19)
- 18 (stop) button (15, 19)
- 19 (CD tray open/close) buttons (15)
Pressing one of these buttons also turns on the unit.
- 20 Disc number buttons (CD 1, CD 2, and CD 3) (15, 16, 21)
Pressing one of these buttons also turns on the unit.
- 21 VOLUME control (12)
- 22 CANCEL button (11, 17, 23)
 DEMO button (10)

- 23 DISPLAY button (11)
- 24 TUNING - / + buttons (14)
These buttons do not function as / .
- 25 PROGRAM button (16, 21)
- 26 CD (play/pause) button and lamp (15)
Pressing this button also turns on the unit.
- 27 RANDOM button (17)
- 28 FM/AM button and lamp (14)
Pressing this button also turns on the unit.
- 29 REPEAT button (18)
- 30 ACTIVE BASS EX. (extension) button and lamp (13)
- 31 SOUND MODE button (13)
- 32 EJECT button for deck B (19)
- 33 Deck B cassette holder (19)

Display window

- 1 Audio level indicator
- 2 Main display
 - Shows the source name, frequency, etc.
- 3 BASS (active bass extension) indicator
- 4 Timer indicators
 - , REC, SLEEP, and DAILY indicators
- 5 S.MODE indicator
- 6 CD play mode indicators
 - PRGM (program), RANDOM and REPEAT (ALL/1CD/1) indicators
- 7 Tuner operation indicators
 - ST (stereo) and MONO indicators
- 8 Disc indicators
- 9 Tape operation indicators
 - (tape direction), , A/B (operating deck) and (reverse mode) indicators

Remote Control

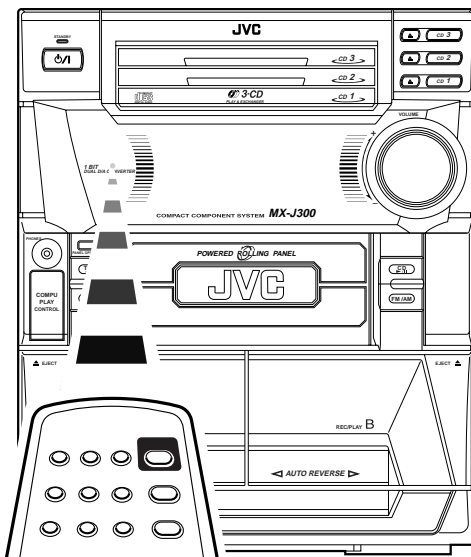
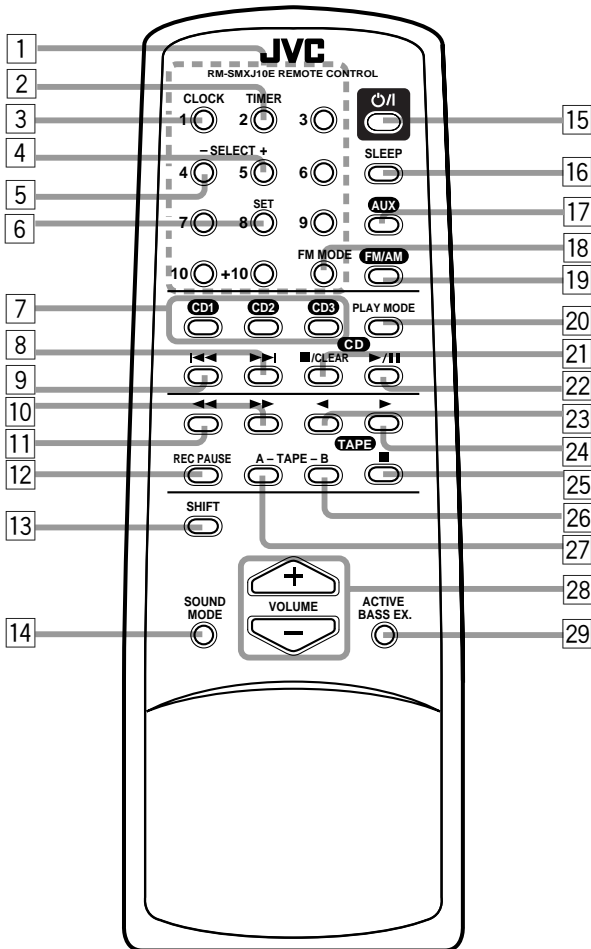

When using the remote control, point it at the remote sensor on the front panel.

Remote Control

- 1 Number buttons (14, 16)
- 2 TIMER button (23, 25)
- 3 CLOCK button (11)
- 4 SELECT + button (11, 23, 25)
- 5 SELECT - button (11, 23, 25)
- 6 SET button (11, 23, 25)
- 7 Disc number buttons (CD 1, CD 2, and CD 3) (15, 16, 21)
Pressing one of these buttons also turns on the unit.
- 8 >>>I (forward search) button (11, 16, 22)
- 9 <<< (reverse search) button (11, 16, 22)
- 10 >>> (fast right) button (19)
- 11 <<< (fast left) button (19)
- 12 REC PAUSE button (20)
- 13 SHIFT button (11, 23, 25)
- 14 SOUND MODE button (13)
- 15 <<<<< (standby/on) button (12)
- 16 SLEEP button (26)
- 17 AUX button (12)
Pressing this button also turns on the unit.
- 18 FM MODE button (14)
- 19 FM/AM button (14)
Pressing this button also turns on the unit.
- 20 PLAY MODE button (16, 17)
- 21 CD <<< (stop) button (15)
CLEAR button (17)
- 22 CD >>>I/II button (15)
Pressing this button also turns on the unit.
- 23 TAPE <<< button (20)
Pressing this button also turns on the unit.
- 24 TAPE >>> button (20)
Pressing this button also turns on the unit.
- 25 TAPE <<<<< (stop) button (19)
- 26 TAPE B button (19)
- 27 TAPE A button (19)
- 28 VOLUME + / - buttons (12)
- 29 ACTIVE BASS EX. (extension) button (13)

Unpacking

After unpacking, check to be sure that you have all the following items.

The number in the parentheses indicates the quantity of the pieces supplied.

- AM (MW/LW) loop antenna (1)
- FM antenna (1)
- Remote control (1)
- Batteries (2)

If any is missing, consult your dealer immediately.

Putting the Batteries into the Remote Control

Insert the batteries — R6P/R6PU(SUM-3)/AA(15F) — into the remote control, by matching the polarity (+ and –) on the batteries with the + and – markings on the battery compartment.

When the remote control can no longer operate the unit, replace both batteries at the same time.

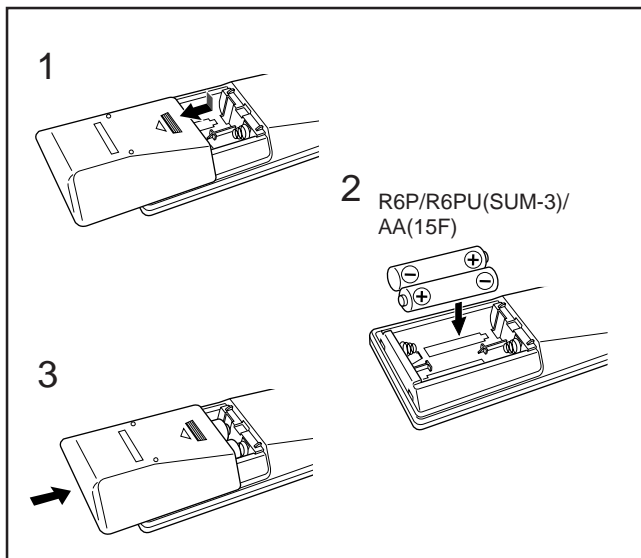

- DO NOT use an old battery together with a new one.
- DO NOT use different types of batteries together.
- DO NOT expose batteries to heat or flame.
- DO NOT leave the batteries in the battery compartment when you are not going to use the remote control for an extended period of time. Otherwise, it will be damaged from battery leakage.

Connecting Antennas

FM antenna

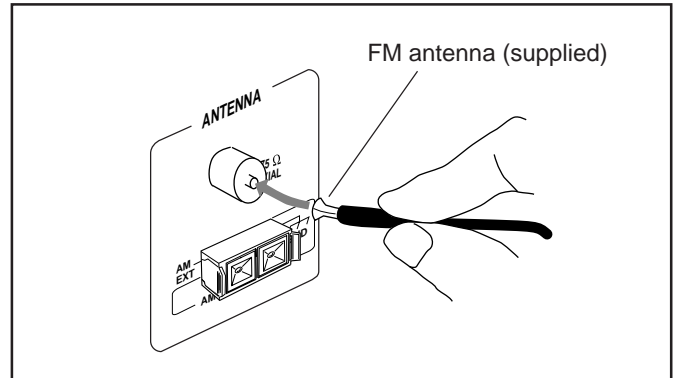

- 1 Attach the FM antenna to the FM 75 Ω COAXIAL terminal.
- 2 Extend the FM antenna.
- 3 Fasten it up in the position which gives you the best reception.



About the supplied FM antenna

The FM antenna supplied with this unit can be used as temporary measure. If reception is poor, you can connect an outdoor FM antenna.

To connect an outdoor FM antenna

Before connecting it, disconnect the supplied FM antenna.

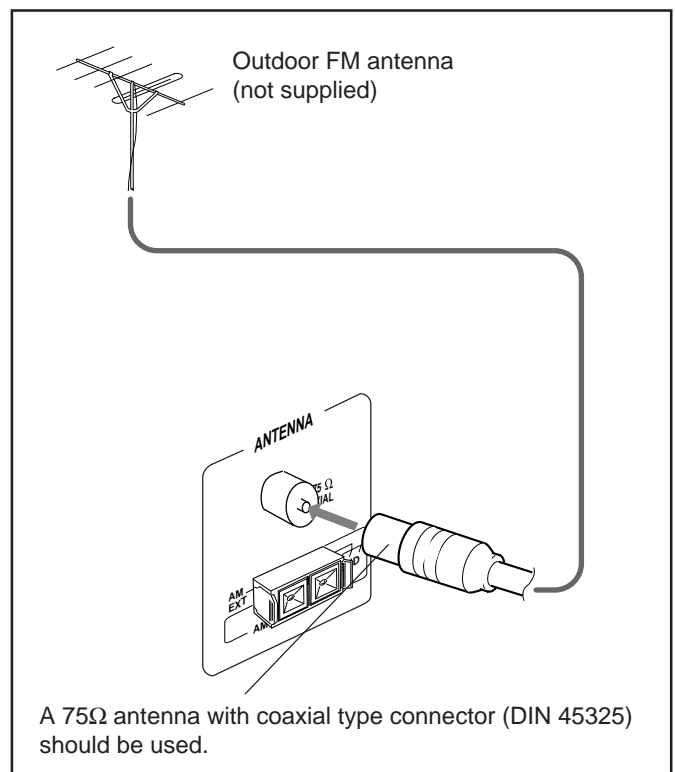

AM (MW/LW) antenna

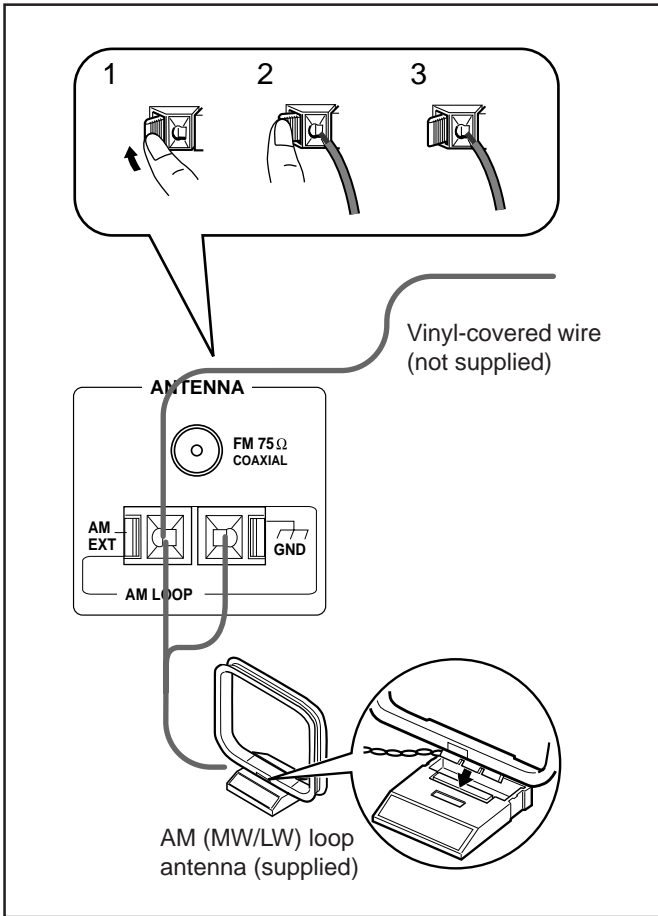

- 1 Connect the AM (MW/LW) loop antenna to the AM LOOP terminals as illustrated.
- 2 Turn the AM (MW/LW) loop antenna until you have the best reception.

To connect an outdoor AM (MW/LW) antenna

When reception is poor, connect a single vinyl-covered wire to the AM EXT terminal and extend it horizontally. (The AM (MW/LW) loop antenna must remain connected.)



notes For better reception of both FM and AM (MW/LW)

- Make sure the antenna conductors do not touch any other terminals and connecting cords.
- Keep the antennas away from metallic parts of the unit, connecting cords, and the AC power cord.

Connecting Speakers

You can connect a pair of the front speakers.

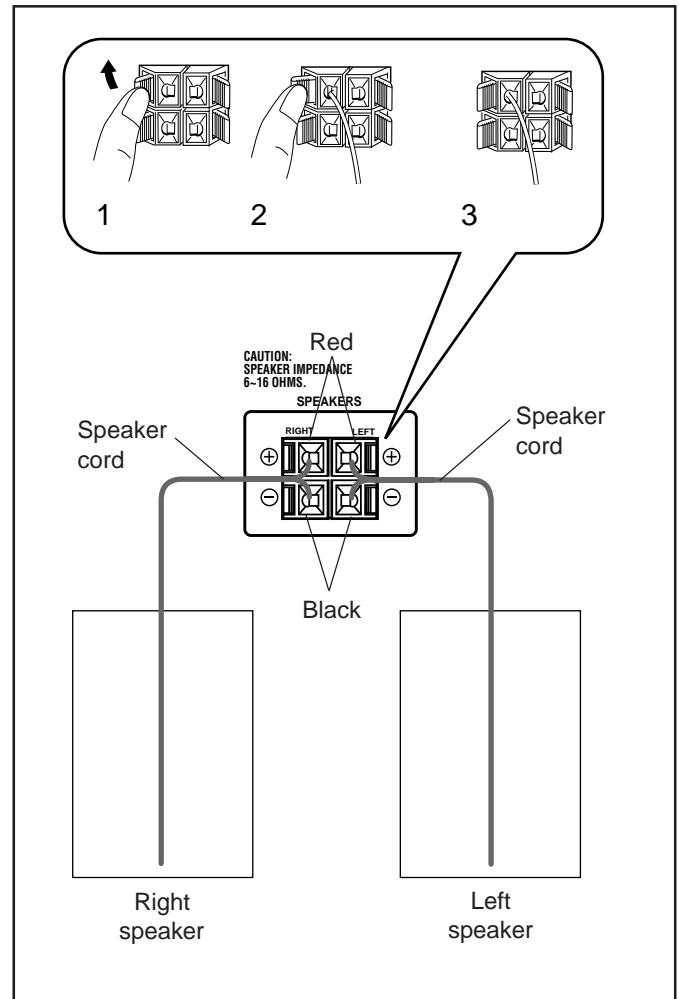

- 1 Press and hold the clamp of the speaker terminal on the rear of the unit.
- 2 Insert the end of the speaker cord into the terminal.
Match the polarity of the speaker terminals: Red (+) to red (+) and black (-) to black (-).
- 3 Release the finger from the clamp.

IMPORTANT: Use only speakers with the same speaker impedance as indicated by the speaker terminals on the rear of the unit.

Connecting Other Equipment

You can connect an audio equipment — used only as a playback device.

When you connect and use this equipment, refer also to its manual.

Be sure that the plugs of the audio cords are color coded: White plugs and jacks are for left audio signals, and red ones for right audio signals.



- DO NOT connect any equipment while the power is on.
- DO NOT plug in any equipment until all connections are complete.

To connect audio equipment

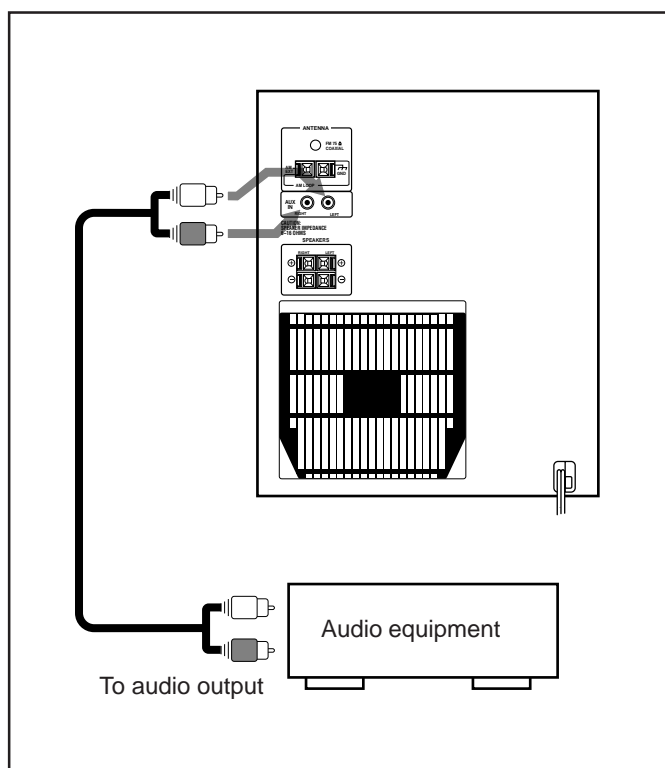

Connect the audio output jacks on the other equipment and the AUX IN jacks on the rear, using an audio cord (not supplied).

NOW, you can plug in the unit and other connected equipment FINALLY!

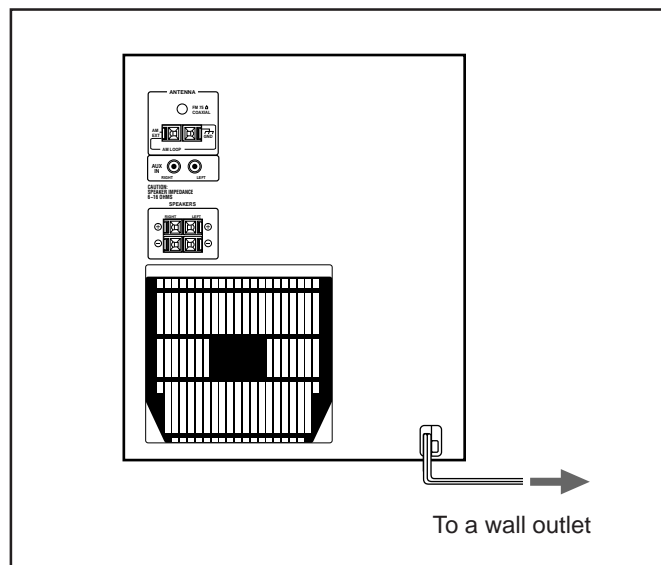

When connecting the AC power cord into a wall outlet, the unit automatically starts display demonstration.

To stop the display demonstration, press any button on the unit or the remote control.

To start the display demonstration manually
Press and hold **DEMO** for more than 2 seconds.

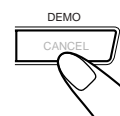

To stop the demonstration, press any button.

Common Operations

Setting the Clock

Before operating the unit any further, first set the clock built in this unit.

For CA-MXJ300 only

Press PANEL OPEN/CLOSE.

The unit is turned on and the Powered Rolling Panel opens automatically.



On the unit:

1 Press CLOCK/TIMER.

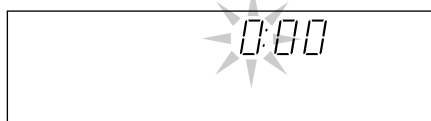

The hour digits start flashing on the display.



2 Press ◀◀ or ▶▶ to adjust the hour, then press SET.

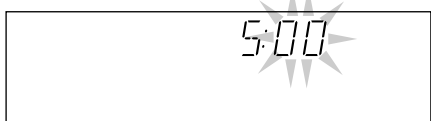

- If you want to correct the hour after pressing SET, press CANCEL. The hour digits start flashing again.

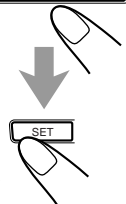

3 Press ◀◀ or ▶▶ to adjust the minute, then press SET.

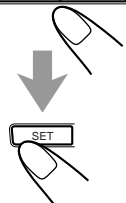

On the remote control:

1 Press SHIFT.

SHIFT



2 Press CLOCK.

CLOCK

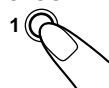

The hour digits start flashing on the display.

3 Press SELECT – or + to adjust the hour, then press SET.



- If you want to correct the hour after pressing SET, press CANCEL (on the unit). The hour digits start flashing again.

– SELECT +
4 5



SET



4 Press SELECT – or + to adjust the minute, then press SET.



– SELECT +
4 5

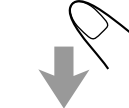

SET



To check the clock time

Press DISPLAY while playing any source.

- Each time you press the button, the source indication and the clock time alternate on the display.

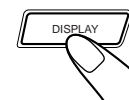

To adjust the clock again

If you have adjusted the clock before, you need to press CLOCK/TIMER repeatedly until the clock setting mode is selected.

- Each time you press the button, the clock/timer setting modes change as follows:

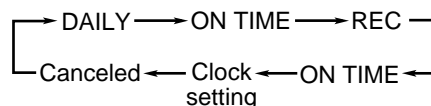

(The hour digits start flashing.)



If there is a power failure

The clock loses the setting and is reset to "0:00." You need to set the clock again.

Turning On the Power and Selecting the Sources

When you press the play button for a particular source (FM/AM, CD ▶/■, TAPE ◀▶, and AUX), the unit turns on. (For CA-MXJ300 only, the Powered Rolling Panel opens automatically.)

The unit starts playing the source if it is ready — COMPUTE PLAY CONTROL.

To listen to the FM/AM (MW/LW) broadcasts, press FM/AM. (See page 14.)

To play back CDs, press CD ▶/■. (See pages 15 – 18.)

To play back tapes, press TAPE ◀▶. (See page 19.)

To select the external equipment as the source, press AUX.

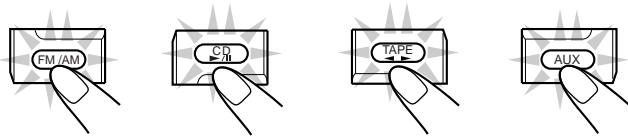

To turn on the unit without playing, press  (standby/on) so that the STANDBY lamp goes off.



(For CA-MXJ300 only, the Powered Rolling Panel opens automatically.)

To turn off the unit (on standby), press  (standby/on) again so that the STANDBY lamp lights up.

(For CA-MXJ300 only, the Powered Rolling Panel also closes.)

A little power is always consumed even while the unit is on standby.

To switch off the power supply completely, unplug the AC power cord from the AC outlet.



When you unplug the AC power cord or if a power failure occurs

The clock is reset to “0:00” right away, while the tuner preset stations (see page 14) will be erased in a few days.

Adjusting the Volume

You can adjust the volume level only while the unit is turned on.

Turn VOLUME clockwise to increase the volume or counterclockwise to decrease it.

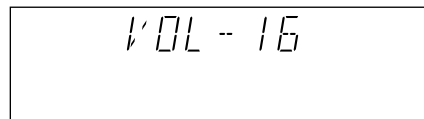
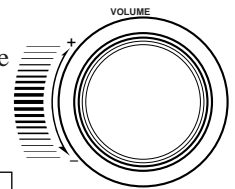

When using the remote control, press VOLUME + to increase the volume or press VOLUME - to decrease it.



For private listening

Connect a pair of headphones to the PHONES jack. No sound comes out of the speakers. Be sure to turn down the volume before connecting or putting on headphones.



DO NOT turn off (on standby) the unit with the volume set to an extremely high level; otherwise, a sudden blast of sound can damage your hearing, speakers and/or headphones when you turn on the unit or start playing any source next time. **REMEMBER** you cannot adjust the volume level while the unit is on standby.

Reinforcing the Bass Sound

The richness and fullness of the bass sound is maintained regardless of how low you set the volume. You can use this effect only for playback.

To get the effect, press ACTIVE BASS EX.

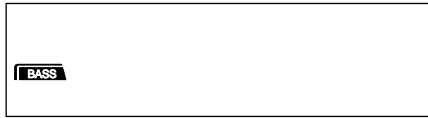

The BASS indicator also lights up on the display.

To cancel the effect, press the button again.

Selecting the Sound Modes

You can select one of the 6 preset sound modes (3 surround modes and 3 SEA – Sound Effect Amplifier – modes). The sound modes can be applied only to playback sounds, and cannot be used for recording.

To select the sound modes, press SOUND MODE until the sound mode you want appears on the display.

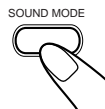
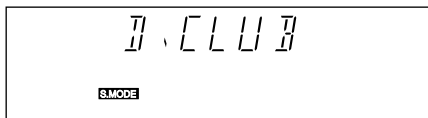

The S.MODE indicator also lights up on the display.

- Each time you press the button, the sound modes change as follows:

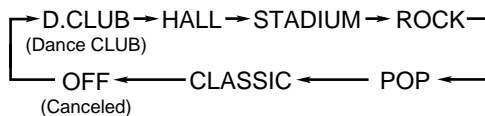

Surround modes:

D.CLUB: Increases resonance and bass.

HALL: Adds depth and brilliance to the sound.

STADIUM: Adds clarity and spreads the sound, like in an outdoor stadium.

SEA modes:

ROCK: Boosts low and high frequency. Good for acoustic music.

POP: Good for vocal music.

CLASSIC: Good for classical music.

OFF: Cancels the sound mode.

Listening to FM and AM (MW/LW) Broadcasts

Tuning in a Station

On the unit ONLY:

1 Press FM/AM.

The unit automatically turns on and tunes in the previously tuned station (either FM or AM — MW/LW). (For CA-MXJ300 only, the Powered Rolling Panel automatically opens.)

- Each time you press the button, the band alternates between FM and AM (MW/LW).

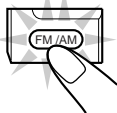

2 Press and hold TUNING - / + for more than 1 second.

The unit starts searching for stations and stops when a station of sufficient signal strength is tuned in.

If a program is broadcast in stereo, the ST (stereo) indicator lights up.

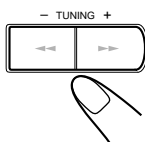

To stop during searching, press TUNING - / +.



When you press TUNING - / + briefly and repeatedly the frequency changes step by step.

To change the FM reception mode

When an FM stereo broadcast is hard to receive or noisy, press FM MODE on the remote control so that the MONO indicator lights up on the display. Reception improves.

FM MODE



To restore the stereo effect, press FM MODE again so that the MONO indicator goes off.

In this stereo mode, you can hear stereo sounds when a program is broadcast in stereo.

Presetting Stations

You can preset 30 FM and 15 AM (MW/LW) stations. In some cases, test frequencies have been already memorized for the tuner since the factory examined the tuner preset function before shipment. This is not a malfunction. You can preset the stations you want into memory by following the presetting method.

- There is a time limit in doing the following steps. If the setting is canceled before you finish, start from step 1 again.

1 Tune in the station you want to preset.

- See “Tuning in a Station” above.

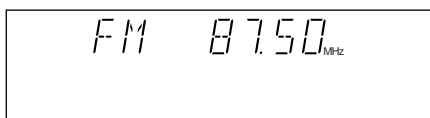

2 Press SET.



3 Press PRESET - / + to select a preset number.

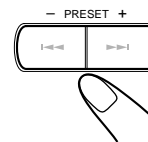
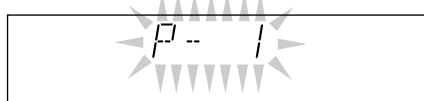

4 Press SET again.

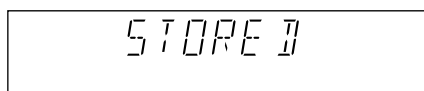

The tuned station in step 1 is stored in the preset number selected in step 3.

- Storing a new station on a used number erases the previously stored one.



When you unplug the AC power cord or if a power failure occurs

The preset stations will be erased in a few days. If this happens, preset the stations again.

Tuning in a Preset Station

1 Press FM/AM.

The unit automatically turns on and tunes in the previously tuned station (either FM or AM — MW/LW.) (For CA-MXJ300 only, the Powered Rolling Panel automatically opens.)

- Each time you press the button, the band alternates between FM and AM (MW/LW).

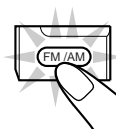

2 Select a preset number.

On the unit:

Press PRESET - / +.

On the remote control:

Press the number buttons.

For preset number 5, press 5.

For preset number 15, press +10 then 5.

For preset number 20, press +10, then 10.

For preset number 25, press +10, +10, then 5.

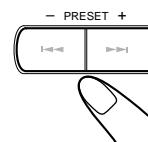

1 2 3

4 5 6

7 8 9

10 +10



Playing Back CDs

Loading CDs

1 Press ▲ for the disc tray (CD 1 to 3) you want to load a CD onto.

The unit automatically turns on and the disc tray comes out. (For CA-MXJ300 only, the Powered Rolling Panel also opens automatically.)

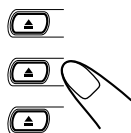

2 Place a disc correctly on the circle of the disc tray, with its label side up.

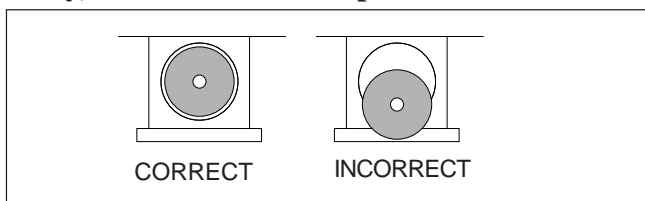

- When using a CD single (8 cm), place it on the inner circle of the disc tray.

3 Press the same ▲ you have pressed in step 1.

The disc tray closes, and the corresponding disc number indicator (CD 1 to CD 3) lights up on the display.

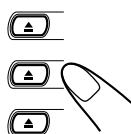

4 Repeat steps 1 to 3 to place other CDs.



When loading more than one CD continuously

When you press ▲ for the next tray you want to place another CD onto, the first disc tray automatically closes and then the next tray comes out.



About the disc indicators

Each disc indicator corresponds to the disc tray of the same number.

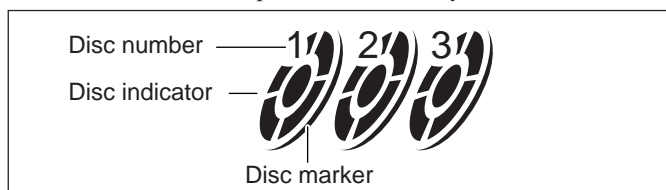

- The disc marker lights up for the disc number you have selected.
- The disc indicator flashes while the corresponding CD is being played.
- The disc indicator goes off when the unit has detected that there is no CD on the corresponding disc tray.

Playing Back the Entire Discs — Continuous Play

You can play CDs continuously.

1 Load CDs.

2 Press one of the disc number buttons (CD 1, CD 2, and CD 3) for the disc you want to play.

CD play starts from the first track of the selected disc.

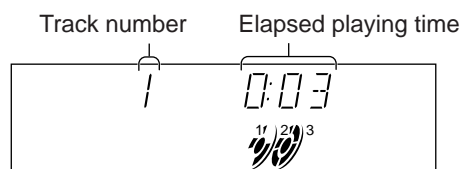
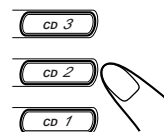

- Pressing CD ►/|| instead of the disc number buttons starts playing back if a CD is on the trays.

To stop during play, press ■ on the unit (or CD ■/CLEAR on the remote control).

To remove the disc, press ▲ for the corresponding disc tray.



CD playback sequence

When 3 CDs are loaded in the disc trays, they are played in one of the following sequences.

- When CD 1 is pressed : CD 1 ⇒ CD 2 ⇒ CD 3 (then stops)
- When CD 2 is pressed : CD 2 ⇒ CD 3 ⇒ CD 1 (then stops)
- When CD 3 is pressed : CD 3 ⇒ CD 1 ⇒ CD 2 (then stops)
- * When only 2 CDs are loaded, they are played in the same order, but the disc tray without a CD is skipped.

Basic CD Operations

While playing a CD, you can do the following operations.

To exchange CDs during playback of another

Press ▲ corresponding to a CD, not playing or selected currently, to eject and exchange the CD.

If you exchange CDs during play, the current play will not stop until all CDs you have exchanged are played.

To stop play for a moment

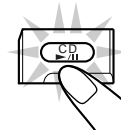

Press CD ►/||.





While pausing, the elapsed playing time flashes on the display.



To resume play, press CD ►/|| again.

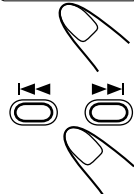

To locate a particular point in a track

During play, press and hold  or .

- : Fast reverses the disc.
- : Fast forwards the disc.

**To go to another track**

Press  or  repeatedly before or during playback.

- : Goes back to the beginning of the current or previous tracks.
- : Skips to the beginning of the next or succeeding tracks.

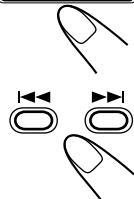

notes If you press and hold  /  before playing you can change the tracks continuously.

To go to another track directly using the number buttons

Pressing the number button(s) before or during play allows you to start playing the track number you want. When a track number button is pressed, CD play starts from the track of the currently selected disc.

Ex.: For track number 5, press 5.

For track number 15, press +10 then 5.

For track number 20, press +10, then 10.

For track number 32, press +10, +10, +10, then 2.

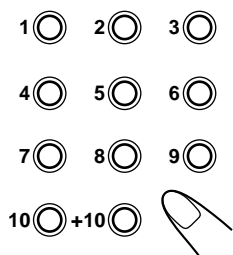
**2 Select the Program play mode.****On the unit:**

Press PROGRAM.

**On the remote control:**

Press PLAY MODE repeatedly until the PRGM indicator lights on the display. Each time you press the button, the CD play mode changes as follows:



Program play → Random play → Continuous play
→ (back to the beginning)

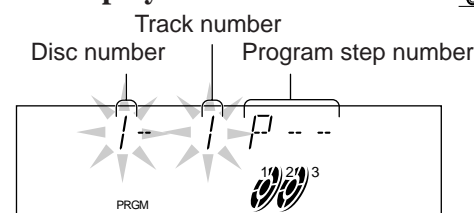
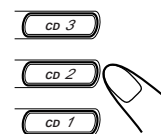

- If a program has been stored in memory, the program is called up.

3 Press one of the disc number buttons (CD 1, CD 2, and CD 3) to select the disc number you want to play.**4 Select a track from the CD selected in the above step.****On the unit:**

Press  or  to select the track number, then press SET.

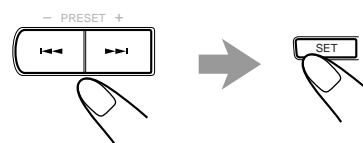
**On the remote control:****Press the number buttons.**

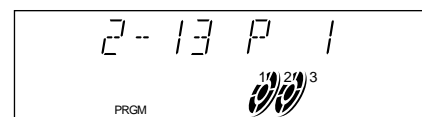
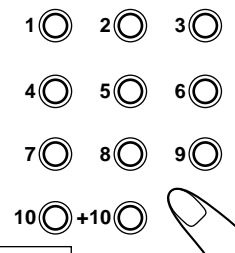

- For how to use the number buttons, see "To go to another track directly using the number buttons" described to the left.

**Programming the Playing Order of the Tracks — Program Play**

You can arrange the order in which the tracks play before you start playing. **You can program up to 32 tracks.**

- To use Repeat play for Program play, press REPEAT after starting Program play.

1 Load discs.

- If the current playing source is not the CD player, press CD , then  on the unit (or CD /CLEAR on the remote control) before going to the next step.

5 Program other tracks you want.

- To program tracks from the same disc, repeat step 4.
- To program tracks from a different disc, repeat steps 3 and 4.

6 Press CD .

The tracks are played in the order you have programmed.

To stop during play, press ■ on the unit (or CD ■/CLEAR on the remote control).

To exit from program play mode

On the unit:

Press PROGRAM again before or after play so that the unit enters Continuous play mode.

On the remote control:

Press PLAY MODE repeatedly until all the CD play mode indicator go off from the display.

- The program you have made is stored in memory until you erase the program.

To check the program contents

Before playing, you can check the program contents by pressing ◀◀ or ▶▶ on the remote control.

- ▶▶: Shows the programmed tracks in the programmed order.
- ◀◀: Shows them in the reverse order.

To modify the program

Before play, you can erase the programmed tracks shown on the display by pressing CANCEL.

- Each time you press the button, the programmed track shown on the display is erased from the program.



To add tracks in the program before play, simply select the disc numbers and the track numbers you want to add by following steps 3 and 4 of the programming procedure on page 16.

To erase the entire program before or after play, press ■ on the unit (or CD ■/CLEAR on the remote control).

“PROGRAM” appears on the display.

- Ejecting a CD will also erase the track numbers programmed from the ejected CD.



If you try to program a 33rd step

“FULL” will appear on the display.



If your entry is ignored

You have tried to program a track from an empty tray, or a track number that does not exist on the CD (for example, selecting track 14 on a CD that only has 12 tracks). Such entries are ignored.

Playing at Random — Random Play

The tracks of all loaded CDs will play at random.

- To use Repeat play for Random play, press REPEAT after starting Random play.

1 Prepare CDs.

- If the current playing source is not the CD player, press CD ▶/II, then ■ on the unit (or CD ■/CLEAR on the remote control) before going to the next step.

2 Select the Random play mode.

On the unit:

Press RANDOM.



On the remote control:

Press PLAY MODE repeatedly until the RANDOM indicator lights on the display. Each time you press the button, the CD play mode changes as follows:



Program play → Random play → Continuous play
→ (back to the beginning)

3 Press CD ▶/II.

The tracks are played at random.

Random play ends when all the tracks are played once.

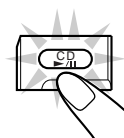

To stop during play, press ■ on the unit (or CD ■/CLEAR on the remote control).

- Random play also stops when one of the disc trays is opened.

To exit from Random play mode, press RANDOM again before or after play so that the unit enters Continuous play mode.



Even if you press ◀◀

You cannot go back to the previous tracks during Random play.

- If you press ▶▶, you can go to next random tracks.

Repeating Tracks or CDs — Repeat Play

You can have all the CDs, the program or the individual track currently playing repeat as many times as you like.

To repeat play, press REPEAT during or before playing. To use Repeat play for Program play and Random play, press the button after starting playback.



- Each time you press the button, Repeat play mode changes as follows, and the following indicator lights up on the display:

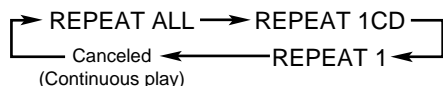

REPEAT ALL: Repeats all the tracks on all the CDs (continuously or at random), or all the tracks in the program.

REPEAT 1CD*: Repeats all the tracks on one CD.

REPEAT 1: Repeats one track on one CD.

- * REPEAT 1CD is not used for Program play and Random play.

To cancel Repeat play, press REPEAT repeatedly until the REPEAT indicator (REPEAT ALL, REPEAT 1CD, or REPEAT 1) goes off from the display.

- Repeat play is also canceled when you press PROGRAM or RANDOM.

Prohibiting Disc Ejection — Tray Lock

You can prohibit CD ejection from the unit and can lock discs.

- This operation is possible only using the buttons on the unit.

To prohibit disc ejection, press ▲ for any disc tray while holding ■. (If there is any disc tray opened, close it first.) “LOCKED” appears for a while, and the loaded CDs are locked.

To cancel the prohibition and unlock the CDs, press ▲ for any disc tray while holding ■.

“UNLOCKED” appears for a while, and the loaded CDs are unlocked.



If you try to eject CDs

“LOCKED” appears to inform you that the Tray Lock is in use.

Playing Back Tapes

This unit provides two types of cassette deck: Deck A for one-way playing only and deck B for Reverse Mode playing as well as one-way playing.

You can play back type I, type II and type IV tapes without changing any settings.

Playing Back a Tape

- 1** Press EJECT (▲) for the deck you want to use.

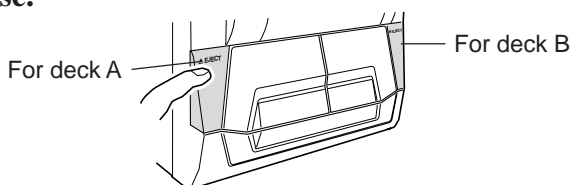

- 2** Put a cassette in, with the exposed part of the tape down.

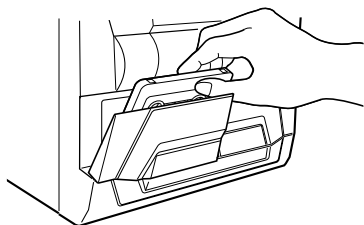

- 3** Close the cassette holder gently.

If you put cassettes in both decks A and B, the last deck you have put a cassette into is selected.

To operate the other deck, press TAPE A/B (or TAPE A or TAPE B on the remote control).

- 4** On the unit:

Press TAPE ◀▶.



On the remote control:

Press TAPE ▶ for forward direction playback, or press TAPE ◀ for reverse direction playback.

When the deck A is selected:

The tape plays only the front side and the tape direction indicator (▶) starts flashing slowly.

When the tape plays to the end, the deck automatically stops.

When the deck B is selected:

The tape play starts and the tape direction indicator (◀▶) starts flashing slowly to indicate the tape running direction.

- Each time you press the button, the tape direction changes:
 - ▶ : plays the front side.
 - ◀ : plays the reverse side.

When the tape plays to the end, the deck automatically stops if the Reverse Mode is not on. (See "To play both sides repeatedly — Reverse Mode.")

To stop during play, press ■.

To operate the other deck, press TAPE A/B (or TAPE A or TAPE B on the remote control), then TAPE ◀▶.

To fast wind to the left or to the right, press ◀◀ or ▶▶ (or ◀◀ or ▶▶ on the remote control).

The tape direction indicator (◀▶) starts flashing quickly on the display.

To remove the cassette, press ▲ EJECT for deck A or EJECT ▲ for deck B.

To play both sides repeatedly — Reverse Mode

Reverse Mode works for deck B.

When it is in use, the tape automatically reverses at the end of a side and the unit starts playing the other side of the tape, and repeats the same process.

To use Reverse Mode, press REVERSE MODE so that the Reverse Mode indicator on the display lights up as — (↻) .

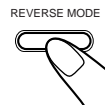

- Each time you press the button, the display changes to show the following:

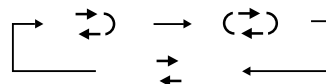

- (↻) : The Cassette Deck automatically stops after playing both sides of the tape. (Stops when playback in the ◀ direction is finished.)
- (↻) : The Cassette Deck continues to play both sides of the tape until the ■ button is pressed.
- ▶ / ◀ : The Cassette Deck automatically stops after playing one side of the tape.

To cancel Reverse Mode, press the button again so that the Reverse Mode indicator on the display lights up as — ▶◀ .



The use of the C-120 or thinner tape is not recommended, since characteristic deterioration may occur and this tape easily jams in the pinch-rollers and the capstans.

IMPORTANT:

- It may be unlawful to record or play back copyrighted material without the consent of the copyrighted owner.
- The recording level is automatically set correctly, so it is not affected by the VOLUME control. Thus, during recording you can adjust the sound you are actually listening to without affecting the recording level.
- While recording, you can hear sound modes and/or the active bass extension effect through the speakers or headphones. However, the sound is recorded without these effects (see page 13).
- If recordings you have made have excessive noise or static, the unit may be too close to a TV. Increase the distance between the TV and the unit.
- You can use type I and II tapes for recording.

To protect your recording

Cassettes have two small tabs on the back to protect unexpected erasure or re-recording.

To protect your recording, remove these tabs.

To re-record on a protected tape, cover the holes with adhesive tape.

When using type II tape, be careful not to cover the holes used to detect the tape type.

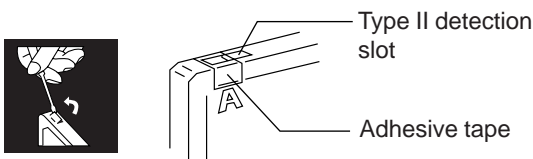

Recording Tapes on Deck B



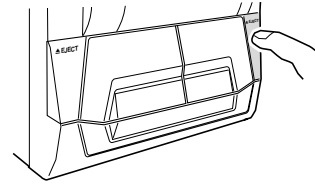

1 Press EJECT for the deck B.



2 Put in a recordable cassette, with the exposed part of the tape down.

3 Close the cassette holder gently.

4 Check the tape direction of deck B.

- If the tape direction is not correct, press TAPE   twice then  to change the tape direction.
- If you want to record on both sides of a tape, press REVERSE MODE until the  indicator is lit.

5 Start playing the source — FM, AM*, CD player, deck A, or auxiliary equipment connected to AUX jacks.

- When the source is CD, you can also use CD Direct Recording (see page 21).
- When the source is deck A, you can also use the dubbing method. (See “Dubbing Tapes” on page 21.)

* See “To record an AM (MW/LW) station – Beat Cut” on page 21.

6 Start recording.

On the unit:

Press REC START/STOP.

The **REC** indicator lights up on the display and recording starts.



On the remote control:

1) Press REC PAUSE.

The **REC** indicator starts flashing on the display.



2) Press TAPE or TAPE .

The **REC** indicator stops flashing and remains lit, and recording starts.



To stop during recording, press REC START/STOP again, or press .

To stop recording temporarily (except when the playback source is deck A), press REC PAUSE on the remote control.

The REC indicator flashes on the display.

REC PAUSE



To resume recording, press TAPE ◀▶ on the unit (or TAPE ◀ or TAPE ▶ on the remote control). The REC indicator stops flashing and remains lit.

To remove the cassette, press EJECT ▲ for deck B.

To record on both sides — Reverse Mode

Press REVERSE MODE so that the Reverse Mode indicator lights up as — ↺.

REVERSE MODE



- When using the Reverse Mode for recording, start recording in the forward (▶) direction first. Otherwise, recording will stop when recording is done only on one side (reverse) of the tape.

To cancel Reverse Mode, press the button again so that the Reverse Mode indicator lights up as — ↻.

To record an AM (MW/LW) station — Beat Cut

While recording an AM (MW/LW) broadcast, beats may be heard (which are never heard when listening to the broadcast without recording it).

If this occurs, press PROGRAM repeatedly, while recording, until the beats are reduced.

- Each time you press the button, the display changes to show the following:

PROGRAM

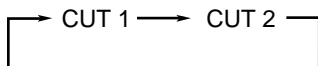

Dubbing Tapes

When dubbing tapes, make sure that the playback direction of deck A and deck B are the same.

1 Press TAPE ◀▶, then ■.

2 Put the source cassette in deck A, and a recordable cassette into deck B.

- Put the cassettes in both decks so that the tapes will run in the forward (▶) direction.

3 Press DUBBING.

Dubbing starts.

DUBBING



To stop during dubbing, press ■.

To remove the cassette, press ▲ EJECT for deck A and EJECT ▲ for deck B.

To record on both sides — Reverse Mode

Press REVERSE MODE so that the Reverse Mode indicator lights up as — ↺.

To cancel Reverse Mode, press the button again so that the Reverse Mode indicator lights up as — ↻.

CD Direct Recording

Everything on the CD goes onto the tape in the order it is on the CD, or according to the order you have made for Program play.

1 Put a recordable cassette into deck B.

2 Place a disc correctly on the circle of the disc tray, with its label side up.

3 Press one of the disc number buttons (CD 1 to CD 3) to select the disc, then ■.

CD 3

CD 2

CD 1

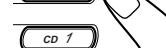

4 Press CD REC START.

“CD REC” appears, and the REC indicator lights up on the display.

Deck B starts recording and the CD player starts playing.

When the recording is done, “CD REC FINISHED” appears on the display, and the CD player and deck B stop.

CD REC START



To stop during CD Direct Recording, press ■.

To remove the cassette, press EJECT ▲ for deck B.

To record on both sides — Reverse Mode

Press REVERSE MODE so that the Reverse Mode indicator lights up as — ↺.

- When using the Reverse Mode for CD Direct Recording, put a recordable cassette tape into deck B with the front side facing the holder and start recording in the forward (▶) direction first. When the tape reaches its end while recording a song in the forward direction (▶), the last song will be recorded at the beginning of the reverse side (◀).

If you start recording on the reverse side (◀), recording will stop when recording is done only on one side (reverse) of the tape.

To cancel Reverse Mode, press the button again so that the Reverse Mode indicator lights up as — ↻.

There are three timers available — Recording Timer, Daily Timer, and Sleep Timer.

Before using the timers, you need to set the clock built in the unit. (See page 11.)

Using Daily Timer

With Daily Timer, you can wake to your favorite music or radio program.

How Daily Timer actually works

The unit automatically turns on, set the volume level to the preset level, and starts playing the specified source when the on-time comes (the ☺ indicator flashes just before the on-time, and continues flashing while the timer is operating). Then, when the off-time comes (“OFF” flashes just before the off-time), the unit automatically turns off (stands by).

The timer setting remains in memory until you change it.

- There is a time limit in doing the following steps. If the setting is canceled before you finish, start from step 1 again.

- If you have made a mistake while setting timer, press CANCEL. (However, this does not always work. If CANCEL does not work, press CLOCK/TIMER repeatedly and start from step 1 again.)

On the unit:

1 Press **CLOCK/TIMER** until “DAILY” appears on the display.

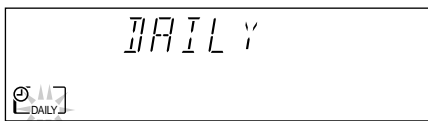

The DAILY indicator also starts flashing on the display.

- Each time you press the button, the timer setting mode changes as follows:

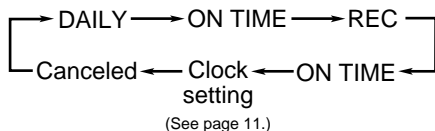

2 Press **CLOCK/TIMER** again.

“ON TIME” appears for 2 seconds, then the unit enters on-time setting mode.

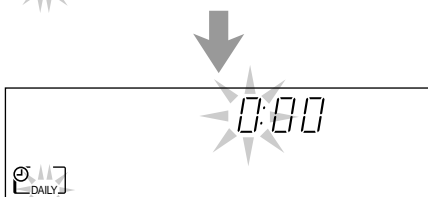

3 Set the on-time you want the unit to turn on.

- 1) Press **◀◀** or **▶▶** to set the hour, then press **SET**.
- 2) Press **◀◀** or **▶▶** to set the minute, then press **SET**.
“OFF TIME” appears for 2 seconds, then the unit enters off-time setting mode.

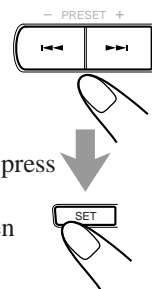

4 Set the off-time you want the unit to turn off (on standby).

- 1) Press **◀◀** or **▶▶** to set the hour, then press **SET**.
- 2) Press **◀◀** or **▶▶** to set the minute, then press **SET**.
The unit enters source selecting mode.

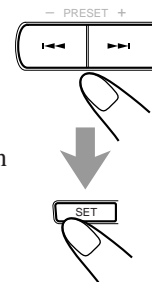

5 Press **◀◀** or **▶▶** to select the source to play, then press **SET**.

- Each time you press **◀◀** or **▶▶**, the source changes as follows:

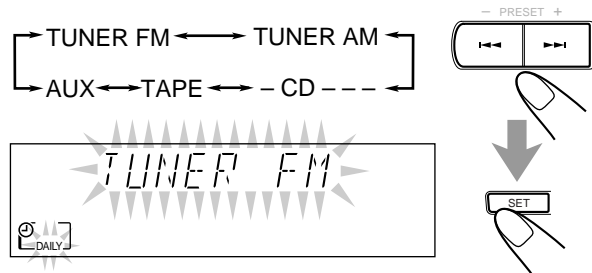

- TUNER FM: tunes into a specified preset FM station. → go to step 6.
- TUNER AM: tunes into a specified preset AM (MW/LW) station. → go to step 6.
- CD - - -: plays a disc from a specified track of a specified disc. → go to step 6.
 - Make sure there is a CD on the selected disc number tray.
- TAPE: plays a tape in deck A or B. → go to step 7.
 - Make sure that a tape is in the deck whose deck indicator (A or B) is lit on the display.
 - Make sure that the tape direction is correct.
- AUX: plays an external source. → go to step 7.
 - To use this setting, the external component has to be equipped with the timer function.

6 When selecting “- CD - - -”

1) Press ◀◀ or ▶▶ to select the disc number, then press SET.

2) Press ◀◀ or ▶▶ to set the track number, then press SET.

The unit enters volume setting mode.

When selecting “TUNER FM” or “TUNER AM”

Press ◀◀ or ▶▶ to select the preset station number, then press SET.

The unit enters volume setting mode.

7 Press ◀◀ or ▶▶ to set the volume level.

- You can select the volume level from among four levels. If you select “VOL -- --,” the volume is set to the last level when the unit has been turned off.



8 Press SET to complete the Daily Timer setting.

The DAILY indicator stops flashing and remains lit. The settings you have done are shown on the display in sequence.

9 Press ⏻/⏻ (standby/on) to turn off the unit (on standby) if you have set the Daily Timer with the unit turned on.

To turn on or off Daily Timer after its setting is done

1 Press CLOCK/TIMER repeatedly until “DAILY” appears on the display.

2 To turn off the Daily Timer, press CANCEL.

The DAILY indicator goes off and “OFF” appears on the display.

The Daily Timer is canceled, but the setting for the Daily Timer remains in memory.

To turn on the Daily Timer, press SET.

The DAILY indicator lights up on the display. The settings you have done are shown on the display in sequence for your confirmation.



If the unit is turned on when the timer-on time comes Daily Timer does not work.

On the remote control:

1 Press SHIFT.



2 Press TIMER.

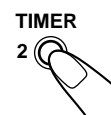

The DAILY indicator also starts flashing on the display.

- Each time you press the button, the timer setting mode changes as follows:

DAILY → ON TIME → REC → ON TIME → Clock setting (See page 11.) → Canceled

3 Press TIMER again.

“ON TIME” appears for 2 seconds, then the unit enters on-time setting mode.

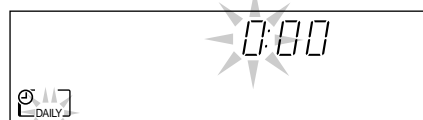
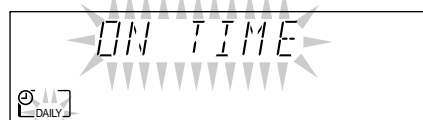

4 Set the on-time you want the unit to turn on.

1) Press SELECT - or SELECT + to set the hour, then press SET.

2) Press SELECT - or SELECT + to set the minute, then press SET.

“OFF TIME” appears for 2 seconds, then the unit enters off-time setting mode.

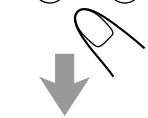

5 Set the off-time you want the unit to turn off (on standby).

1) Press SELECT - or SELECT + to set the hour, then press SET.

2) Press SELECT - or SELECT + to set the minute, then press SET.

The unit enters source selecting mode.

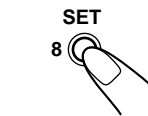
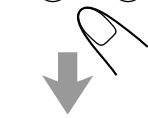

6 Press SELECT – or SELECT + to select the source to play, then press SET.

- Each time you press SELECT – or SELECT +, the source changes as follows:



TUNER FM: tunes into a specified preset FM station.
→ go to step 7.

TUNER AM: tunes into a specified preset AM (MW/LW) station. → go to step 7.

– CD – – –: plays a disc from a specified track of a specified disc. → go to step 7.

- Make sure there is a CD on the selected disc number tray.

TAPE: plays a tape in deck A or B. → go to step 8.

- Make sure that a tape is in the deck whose deck indicator (A or B) is lit on the display.
- Make sure that the tape direction is correct.

AUX: plays an external source. → go to step 8.

- To use this setting, the external component has to be equipped with the timer function.

7 When selecting “– CD – – –”

- Press SELECT – or SELECT + to select the disc number, then press SET.
- Press SELECT – or SELECT + to set the track number, then press SET.
The unit enters volume setting mode.

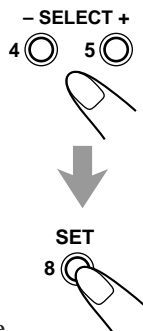

When selecting “TUNER FM” or “TUNER AM”

Press SELECT – or SELECT + to select the preset station number, then press SET.
The unit enters volume setting mode.

8 Press SELECT – or SELECT + to set the volume level.

- You can select the volume level from among four levels. If you select “VOL – – –,” the volume is set to the last level when the unit has been turned off.



9 Press SET to complete the Daily Timer setting.

The DAILY indicator stops flashing and remains lit. The settings you have done are shown on the display in sequence.

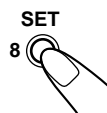

10 Press ⏻/⏻ (standby/on) to turn off the unit (on standby) if you have set the Daily Timer with the unit turned on.



Using Recording Timer

With Recording Timer, you can make a tape of a radio broadcast automatically.

How Recording Timer actually works

The unit automatically turns on, tunes into the specified station, sets the volume level to “MIN,” and starts recording when the on-time comes (the Ⓞ indicator flashes just before the on-time, and continues flashing while the timer is operating). Then, when the off-time comes (“OFF” appears just before the off-time), the unit automatically turns off (stands by).

The timer setting remains in memory until you change it.

- There is a time limit in doing the following steps. If the setting is canceled before you finish, start from step 1 again.
- If you have made a mistake while setting the timer, press CANCEL. (However, this does not always work. If CANCEL does not work, press CLOCK/TIMER repeatedly and start from step 1 again.)

On the unit:

1 Put a recordable cassette into deck B.

2 Press CLOCK/TIMER until “REC” appears on the display.



The REC indicator also starts flashing on the display.

- Each time you press the button, the timer setting mode changes as follows:

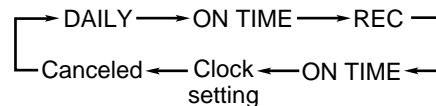

(See page 11.)

3 Press CLOCK/TIMER again.

“ON TIME” appears for 2 seconds, then the unit enters on-time setting mode.

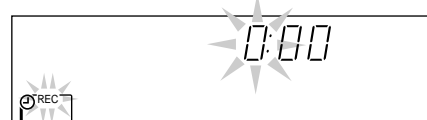
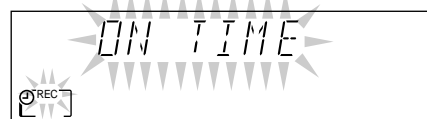

4 Set the on-time you want the unit to turn on.

- 1) Press ◀◀ or ▶▶ to set the hour, then press SET.
- 2) Press ◀◀ or ▶▶ to set the minute, then press SET.
“OFF TIME” appears for 2 seconds, then the unit enters off-time setting mode.

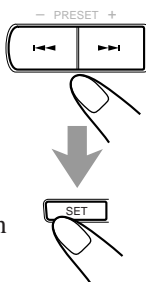

5 Set the off-time you want the unit to turn off (on standby).

- 1) Press ◀◀ or ▶▶ to set the hour, then press SET.
- 2) Press ◀◀ or ▶▶ to set the minute, then press SET.

The unit enters preset station selecting mode.

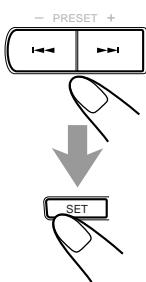

6 Select the preset station.

- 1) Press ◀◀ or ▶▶ to select the band (“TUNER FM” or “TUNER AM”), then press SET.

- 2) Press ◀◀ or ▶▶ to select a preset channel number, then press SET.

The REC indicator stops flashing and remains lit. The settings you have done are shown on the display in sequence.

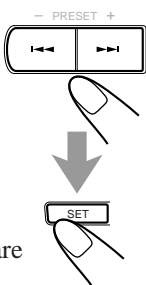

7 Press ⏻/⏻ (standby/on) to turn off the unit (on standby) if necessary.



notes If you want to listen to another source while recording

Press REC START/STOP to stop recording. Without stopping it, you cannot change the source.



To turn on or off Recording Timer after its setting is done

- 1 Press CLOCK/TIMER repeatedly until “REC” appears on the display.



- 2 To turn off the Recording Timer, press CANCEL (on the unit only).

The REC indicator goes off and “OFF” appears on the display.

The Recording Timer is canceled, but the setting for the Recording Timer remains in memory.

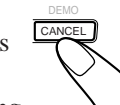

To turn on the Recording Timer, press SET.

The REC indicator lights up on the display. The settings you have done are shown on the display in sequence for your confirmation.

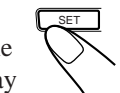

On the remote control:

- 1 Put a recordable cassette into deck B.

- 2 Press SHIFT.



- 3 Press TIMER until “REC” appears on the display.

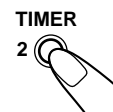

The REC indicator also starts flashing on the display.

- Each time you press the button, the timer setting mode changes as follows:

DAILY → ON TIME → REC → ON TIME → Clock setting (See page 11.) → Canceled

- 4 Press TIMER again.

“ON TIME” appears for 2 seconds, then the unit enters on-time setting mode.

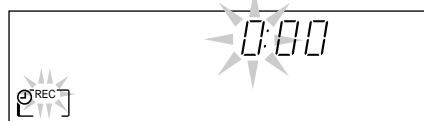
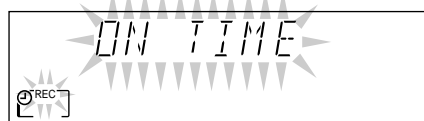
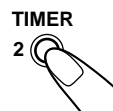

- 5 Set the on-time you want the unit to turn on.

- 1) Press SELECT – or SELECT + to set the hour, then press SET.

- 2) Press SELECT – or SELECT + to set the minute, then press SET.

“OFF TIME” appears for 2 seconds, then the unit enters off-time setting mode.



- 6 Set the off-time you want the unit to turn off (on standby).

- 1) Press SELECT – or SELECT + to set the hour, then press SET.

- 2) Press SELECT – or SELECT + to set the minute, then press SET.

The unit enters source selecting mode.



7 Select the preset station.

- 1) Press SELECT – or SELECT + to select the band (“TUNER FM” or “TUNER AM”), then press SET.
- 2) Press SELECT – or SELECT + to select a preset channel number, then press SET. The REC indicator stops flashing and remains lit. The settings you have done are shown on the display in sequence.

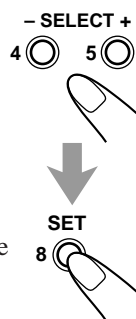

8 Press to turn off the unit (on standby) if necessary.



Using Sleep Timer

With Sleep Timer, you can fall asleep to music. You can set Sleep Timer when the unit is turned on.

How Sleep Timer actually works

The unit automatically turns off after the specified time length passes.

On the remote control ONLY:

1 Press SLEEP.

The time length until the shut-off time appears and the SLEEP indicator starts flashing on the display.

- Each time you press the button, the time length changes as follows:

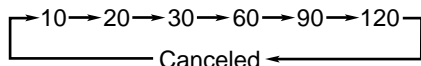

2 Wait for about 5 seconds after specifying the time length.

The SLEEP indicator stops flashing and remains lit.

To check the remaining time until the shut-off time, press SLEEP once so that the remaining time until the shut-off time appears for about 5 seconds.

To change the shut-off time, press SLEEP repeatedly until the desired time length appears on the display.

To cancel the setting, press SLEEP repeatedly so that the SLEEP indicator goes off.

- Sleep Timer is also canceled when you turn off the unit.

Timer Priority

Since each timer can be set separately, you may wonder what happens if the setting for these timers overlaps. Here are examples.

• Recording Timer has priority over Daily Timer and Sleep Timer.

If Daily Timer is set to come on while Recording Timer is operating, Daily Timer will not come on at all.

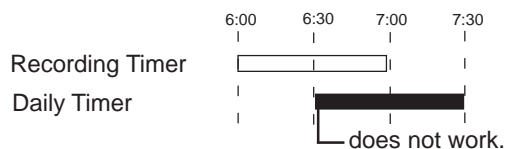

If Recording Timer is set to come on while Sleep Timer is operating, Sleep Timer will not work (the SLEEP indicator does not go off).

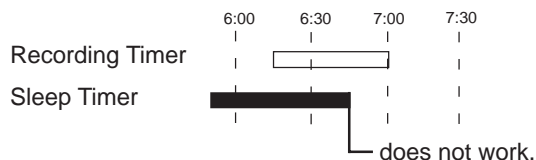

Maintenance

To get the best performance of the unit, keep your discs, tapes, and mechanism clean.

Handling discs



- Remove the disc from its case by holding it at the edge while pressing the center hole lightly.
- Do not touch the shiny surface of the disc, or bend the disc.
- Put the disc back in its case after use to prevent warping.

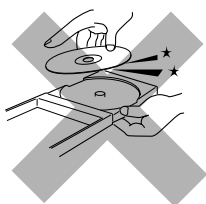

- Be careful not to scratch the surface of the disc when placing it back in its case.
- Avoid exposure to direct sunlight, temperature extremes, and moisture.



To clean the disc

Wipe the disc with a soft cloth in a straight line from center to edge.



DO NOT use any solvent — such as conventional record cleaner, spray, thinner, or benzine — to clean the disc.

Handling cassette tapes

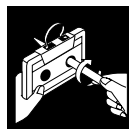

- If the tape is loose in its cassette, take up the slack by inserting a pencil in one of the reels and rotating.
- If the tape is loose, it may get stretched, cut, or caught in the cassette.



- Be careful not to touch the tape surface.



- Avoid the following places to store the tape:
 - In dusty places
 - In direct sunlight or heat
 - In moist areas
 - Near a magnet

Cassette decks

If the heads, capstans, and pinch rollers of the cassette decks become dirty, the following will occur:

- Impaired sound quality
- Discontinuous sound
- Fading
- Incomplete erasure
- Difficulty in recording

To clean the heads, capstans, and pinch rollers

Use a cotton swab moistened with alcohol.

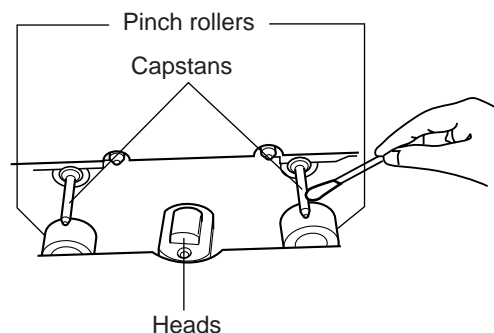

To demagnetize the heads

Turn off the unit, and use a head demagnetizer (available at electronics and record shops).

Troubleshooting

If you are having a problem with your unit, check this list for a possible solution before calling for service.

If you cannot solve the problem from the hints given here, or the unit has been physically damaged, call a qualified person, such as your dealer, for service.

Symptom	Cause	Action
No sound is heard.	Connections are incorrect or loose.	Check all connections and make corrections. (See pages 8 to 10.)
Hard to listen to broadcasts because of noise.	<ul style="list-style-type: none"> Antennas are disconnected. The AM (MW/LW) loop antenna is too close to the unit. The FM antenna is not properly extended and positioned. 	<ul style="list-style-type: none"> Reconnect the antennas correctly and securely. Change the position and direction of the AM (MW/LW) loop antenna. Extend the FM antenna at the best position.
The disc sound is discontinuous.	The disc is scratched or dirty.	Clean or replace the disc. (See page 27.)
The disc tray does not open or close.	<ul style="list-style-type: none"> The AC power cord is not plugged in. Trays are locked. 	<ul style="list-style-type: none"> Plug the AC power cord. Unlock the trays. (See page 18.)
The disc does not play.	The disc is placed upside down.	Place the disc with the label side up.
The cassette holders cannot be opened.	Power supply from the AC power cord has been cut off while the tape was running.	Turn on the unit.
Impossible to record.	Small tabs on the back of the cassette are removed.	Cover the holes with adhesive tape.
Operations are disabled.	The built-in microprocessor may malfunction due to external electrical interference.	Unplug the AC power cord and then plug it back in.
Unable to operate the unit from the remote control unit.	<ul style="list-style-type: none"> The path between the remote control unit and the remote sensor on the unit is blocked. The batteries are exhausted. 	<ul style="list-style-type: none"> Remove the obstruction. Replace the batteries.

Specifications

Design and specifications are subject to change without notice.

Amplifier

Output Power

CA-MXJ300: 70 W per channel, min. RMS, both channels driven into 6 Ω at 1 kHz with no more than 10% total harmonic distortion

CA-MXJ200: 40 W per channel, min. RMS, both channels driven into 6 Ω at 1 kHz with no more than 10% total harmonic distortion

Audio input sensitivity/Impedance (at 1 kHz)

AUX: 300 mV/50 k Ω

Speakers/Impedance: 6 Ω – 16 Ω

Tuner

FM tuning range: 87.50 MHz – 108.00 MHz

AM tuning range: MW: 522 kHz – 1,629 kHz

LW: 144 kHz – 288 kHz

CD player

CD Capacity: 3 CDs

Dynamic range: 85 dB

Signal-to-noise ratio: 90 dB

Wow and flutter: Immeasurable

Cassette deck

Frequency response

Normal (type I): 50 Hz — 14,000 Hz

CrO₂ (type II): 50 Hz — 14,000 Hz

Metal (type IV): 50 Hz — 14,000 Hz (only for playback)

Wow and flutter

0.15% (WRMS)

General

Power requirement: AC 230 V \sim , 50 Hz

Power consumption:

CA-MXJ300: 95 W (at operation)
8 W (on standby)

CA-MXJ200: 85 W (at operation)
9 W (on standby)

Dimensions (approx.): 265 mm x 315 mm x 361 mm (W/H/D)
(10⁷/₁₆ in. x 12⁷/₁₆ in. x 14¹/₄ in.)

Mass (approx.):

CA-MXJ300: 8.7 kg (19.2 lbs)

CA-MXJ200: 7.2 kg (15.9 lbs)

Supplied accessories

See page 8.

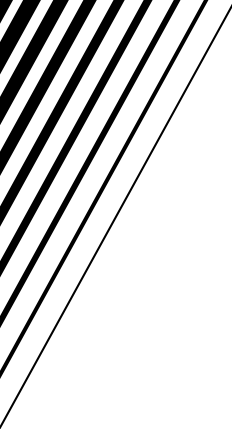

JVC

INSTRUCTIONS



SPEAKER SYSTEM

SP-MXJ300, SP-MXJ200

BEDIENUNGSANLEITUNG: LAUTSPRECHERSYSTEM
MANUEL D'INSTRUCTIONS: SYSTEME DES ENCEINTES
GEBRUIKSAANWIJZING: LUIDSPREKERSYSTEEM
MANUAL DE INSTRUCCIONES: SISTEMA DE ALTAVOCES
ISTRUZIONI: SISTEMA DI ALTOPARLANTI
BRUKSANVISNING: HÖGTALARSYSTEM

Thank you for purchasing JVC speakers.

Before you begin using them, please read the instructions carefully to be sure you get the best possible performance. If you have any questions, consult your JVC dealer.

Vielen Dank für den Kauf dieser JVC-Lautsprecher.

Lesen Sie bitte diese Bedienungsanleitung vor Ingebrauchnahme sorgfältig durch, um stets optimale Ergebnisse zu erzielen. Wenden Sie sich bei etwaigen Fragen bitte an Ihren JVC Händler.

Nous vous remercions pour l'achat de ces enceintes JVC.

Avant de les utiliser, lire ces instructions avec attention pour en obtenir les meilleures performances possibles. En cas de questions, consulter votre revendeur JVC.

Dank u voor de aanschaf van deze luidsprekers.

Lees alvorens over te gaan tot aansluiten, deze gebruiksaanwijzing door zodat u de best mogelijke prestaties zult verkrijgen. Neem contact op met de JVC dealer indien u vragen heeft.

Le estamos muy agradecidos por haber adquirido estos altavoces de JVC. Antes de utilizarlos, sírvase leer las instrucciones detenidamente a fin de obtener el mejor rendimiento posible. Si tienen alguna pregunta, acuda a su agente de JVC.

Grazie per aver acquistato questi altoparlanti della JVC.

Prima di cominciare l'uso degli altoparlanti, leggete attentamente le istruzioni per assicurare le migliori prestazioni. Qualora sorgessero dei dubbi, rivolgetevi al vostro rivenditore JVC.

VEJLEDNING: HØJTTALERSYSTEM
KÄYTTÖOHJE: KAIUTINJÄRJESTELMÄ
INSTRUKCJA UŻYTKOWANIA: ZESTAW GŁOŚNIKOWY
HASZNÁLATI ÚTMUTATÓ: HANGSZÓRÓ RENDSZER
NÁVOD K OBSLUZE: REPRODUKTOROVÁ SOUSTAVA

Tack för ditt val av dessa JVC-högtalare.

Innan du kopplar in högtalarna i din ljudanläggning bör du för att få maximala prestanda från högtalarna läsa igenom bruksanvisningen noggrant. Kontakta din JVC-återförsäljare om du har frågor eller känner dig osäker.

Tak for købet af JVC-højttalerne.

Gennemlæs venligst vejledningen omhyggeligt før de tages i brug, så De kan opnå den bedst mulige ydelse. Forhør hos Deres JVC forhandler hvis De har nogen spørgsmål.

Kiitos siitä että päädyit valinnassasi JVC-kaiuttimiin.

Ennen kuin alat käyttää niitä, lue käyttöohje huolellisesti, jotta ne toimisivat parhaalla mahdollisella tavalla. Jos Sinulla on kysyttävää ota yhteys JVC-edustajaan.

Dziękujemy za wybranie zestawu głośnikowego firmy JVC.

Przed rozpoczęciem użytkowania zestawu głośnikowego prosimy o dokładne zapoznanie się z treścią niniejszej instrukcji użytkowania, aby uzyskać jak najlepszą pracę głośników. W przypadku jakichkolwiek zapytań, prosimy o skonsultowanie się z najbliższym dealerm firmy JVC.

Köszönjük, hogy a JVC hangszóró rendszerét választotta. Annak érdekében, hogy a hangszóró rendszer a legjobb teljesítményt nyújtsa Önnek, használat előtt kérjük figyelmesen olvassa el ezt a használati útmutatót. Ha bármilyen kérdése van, forduljon a legközelebbi JVC márkakereskedőhöz.

Děkujeme Vám, že jste si zakoupili reproduktory JVC.

Drive než je začnete používat, přečtěte si prosím pečlivě návod k obsluze, abyste dosáhli co nejlepší možné funkce. Jestliže máte další otázky, spojte se s svým prodejcem JVC.

— SAFETY INSTRUCTIONS — “SOME DOS AND DON'TS ON THE SAFE USE OF EQUIPMENT”

This equipment has been designed and manufactured to meet international safety standards but, like any electrical equipment, care must be taken if you are to obtain the best results and safety is to be assured.

Do read the operating instructions before you attempt to use the equipment.

Do ensure that all electrical connections (including the mains plug, extension leads and interconnections between pieces of equipment) are properly made and in accordance with the manufacturer's instructions. Switch off and withdraw the mains plug when making or changing connections.

Do consult your dealer if you are ever in doubt about the installation, operation or safety of your equipment.

Do be careful with glass panels or doors on equipment.

DON'T continue to operate the equipment if you are in any doubt about it working normally, or if it is damaged in any way — switch off, withdraw the mains plug and consult your dealer.

DON'T remove any fixed cover as this may expose dangerous voltages.

DON'T leave equipment switched on when it is unattended unless it is specifically stated that it is designed for unattended operation or has a standby mode.

Switch off using the switch on the equipment and make sure that your family know how to do this.

Special arrangements may need to be made for infirm or handi-capped people.

DON'T use equipment such as personal stereos or radios so that you are distracted from the requirements of traffic safety. It is illegal to watch television whilst driving.

DON'T listen to headphones at high volume as such use can permanently damage your hearing.

DON'T obstruct the ventilation of the equipment, for example with curtains or soft furnishing.

Overheating will cause damage and shorten the life of the equipment.

DON'T use makeshift stands and NEVER fix legs with wood screws — to ensure complete safety always fit the manufacturer's approved stand or legs with the fixings provided according to the instructions.

DON'T allow electrical equipment to be exposed to rain or moisture.

ABOVE ALL

- NEVER let anyone, especially children, push anything into holes, slots or any other opening in the case.
- this could result in a fatal electrical shock;
- NEVER guess or take chances with electrical equipment of any kind
- it is better to be safe than sorry!

Amplifier connection
Verstärkeranschluß
Raccordement à l'amplificateur
Aansluiting op de versterker
Anslutning till en förstärkare
Conexión al amplificador
Collegamento dell'amplificatore
Forstærkertilslutning
Vahvistimen liitäntä
Połączenia ze wzmacniaczem
Erősítő csatlakoztatás
Zapojení zesilovače

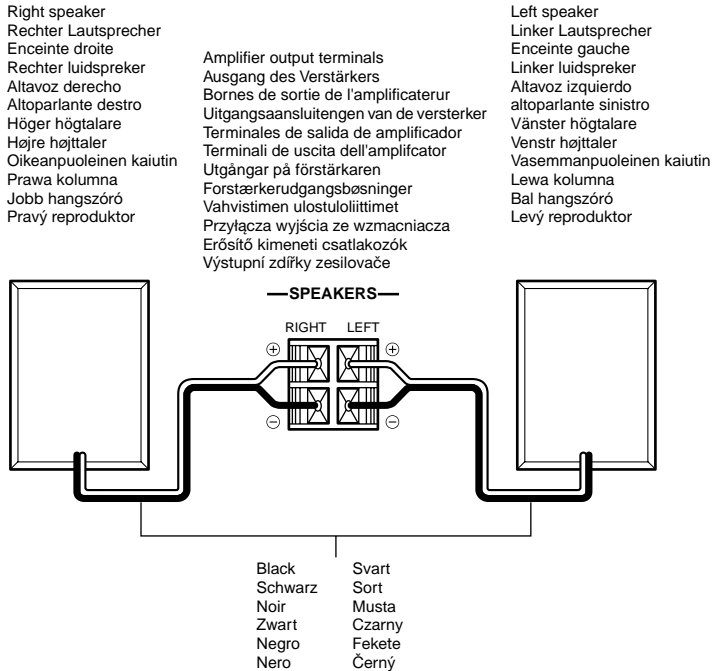

CONNECTION

- Turn off power to the whole system before connecting the speakers to the amplifier.
- The nominal impedance of the SP-MXJ300, SP-MXJ200 is 6 Ω. Select for use an amplifier to which a speaker system with the load impedance of 6 Ω can be connected.
- The maximum power handling capacity of the SP-MXJ300 is 100W and the SP-MXJ200 is 60W. Excessive input will result in abnormal noise and possible damage. In cases where the signals described below are applied to the speakers, even if the signals are below the maximum allowable input, they may cause an overload and burn the wiring of the speakers. Be sure to lower the amplifier volume beforehand.
 - 1) Noise during FM tuning.
 - 2) High level signals containing high frequency components produced by a tape deck in the fast forward mode.
 - 3) Click noise produced when turning power of other components on and off.
 - 4) Click noise produced when connecting or disconnecting cords with the power on.
 - 5) Click noise produced when the cartridge is replaced with the power on.
 - 6) Click noise produced when operating amplifier switches.
 - 7) Continuous high frequency oscillation or high pitch electronically produced musical instrument sound.
 - 8) Howling when using a microphones.

SPECIFICATIONS

Type	: 2-way 2-speaker bass-reflex type
Speaker units	: Dual Duct System
Woofer	: 16 cm (6-5/16 in.) cone × 1
Tweeter	: 4 cm (1-5/8 in.) cone × 1
Power Handling Capacity	
SP-MXJ300	: 100 W
SP-MXJ200	: 60 W
Impedance	: 6 Ω
Frequency Range	: 45 Hz - 22 000 Hz
Sound Pressure Level	: 88 dB/W·m
Dimensions (W × H × D)	: 215 mm × 315 mm × 273 mm (8-1/2 in. × 12-7/16 in. × 10-3/4 in.)
Mass	: 3.5 kg (7.8 lbs) each

Design and specifications subject to change without notice.

ANSCHLUSS

- Schalten Sie vor dem Anschluß der Lautsprecher an den Verstärker die Spannungsversorgung des gesamten Systems aus.
- Die Nennimpedanz der Lautsprecher — Systeme SP-MXJ300, SP-MXJ200 beträgt 6 Ω . Wählen Sie einen Verstärker, an den ein Lautsprechersystem mit einer Lastimpedanz von 6 Ω angeschlossen werden kann.
- Die maximale Belastbarkeit ist 100 W für SP-MXJ300 und 60 W für SP-MXJ200. Eine Überlastung führt zu Verzerrungen und möglicherweise zu Beschädigungen. Signale der unten beschriebenen Art können, auch wenn sie unter dem maximal zulässigen Eingang liegen, eine Überlastung verursachen und die Lautsprecherwicklungen durchbrennen. Verringern Sie vorher die Lautstärke des Verstärkers.
 - 1) Geräusche beim Einstellen von UKW-Sendern.
 - 2) Hochpegelige Signale mit Hochfrequenz-Anteilen, die von Tonbanddecks beim Schnellvorspulen erzeugt werden.
 - 3) Klickgeräusche, wenn die Spannungsversorgung anderer Komponenten ein- und ausgeschaltet wird.
 - 4) Klickgeräusche, wenn Kabel angeschlossen oder abgetrennt werden, während die Spannungsversorgung eingeschaltet ist.
 - 5) Klickgeräusche, wenn der Tonabnehmer des Plattenspielers ausgewechselt wird, während die Spannungsversorgung eingeschaltet ist.
 - 6) Klickgeräusche, die beim Betätigen von Schaltern des Verstärkers erzeugt werden.
 - 7) Ständige Hochfrequenzschwingungen oder elektronisch erzeugte Töne von Musikinstrumenten mit hohen Tonhöhen.
 - 8) Rückkopplungen von Mikrofonen.

TECHNISCHE DATEN

Typ	: 2-Weg, 2-Lautsprecher-Baßreflexbox
Lautsprechereinheiten	: Dual Duct System
Tieftöner	: 16 cm – Konus \times 1
Hochtöner	: 4 cm – Konus \times 1
Belastbarkeit	
SP-MXJ300	: 100 W
SP-MXJ200	: 60 W
Impedanz	: 6 Ω
Frequenzbereiche	: 45 Hz - 22 000 Hz
Schalldruckpegel	: 88 dB/W·m
Abmessungen (W \times H \times T)	: 215 mm \times 315 mm \times 273 mm
Gewicht	: je 3,5 kg.

Technische Änderungen vorbehalten.

RACCORDEMENT

- Mettre hors circuit tout le système avant de raccorder les enceintes à l'amplificateur.
- L'impédance nominale des enceintes SP-MXJ300, SP-MXJ200 est de 6 Ω . Sélectionner un amplificateur acceptant une impédance de charge de haut-parleur de 6 Ω .
- La puissance maximale admissible de la SP-MXJ300 est de 100 W et celle de la SP-MXJ200 est de 60 W. En dépassant la puissance admissible, cela provoquera des bruits anormaux et détériorera les enceintes. Au cas où les signaux décrits ci-dessous sont envoyés aux enceintes, et même si ces signaux sont inférieurs à la puissance d'entrée maximum admissible, ils risquent de provoquer une surcharge ou même un incendie. S'assurer de bien diminuer le volume sonore de l'amplificateur.
 - 1) Parasites durant une syntonisation FM.
 - 2) Signaux de niveau élevé contenant des composants à haute fréquence, comme ceux générés par une platine d'enregistrement en mode avance rapide.
 - 3) Cliquetis se produisant lorsque d'autres appareils sont mis en ou hors circuit.
 - 4) Cliquetis se produisant lorsque des appareils sont branchés ou dé-branchés alors que leur alimentation est en circuit.
 - 5) Cliquetis se produisant lorsque la cellule d'une platine tourne-disque est changée alors que l'alimentation est en circuit.
 - 6) Cliquetis se produisant lorsque les commandes de l'amplificateur sont manipulées.
 - 7) Oscillations continues à haute fréquence ou sons très aigus provenant d'instruments de musique électroniques.
 - 8) Hurlements dus à l'utilisation de micros.

CARACTERISTIQUES

Type	: Enceinte 2 voies, 2 haut-parleurs type à réflexion des basses
Enceintes	: Dual Duct System
Graves	: conique de 16 cm \times 1
Aigus	: conique de 4 cm \times 1
Puissance admissible	
SP-MXJ300	: 100W
SP-MXJ200	: 60W
Impédance	: 6 Ω
Gamme de fréquence	: 45 Hz - 22 000 Hz
Niveau de pression sonore	: 88 dB/W·m
Dimensions (L \times H \times P)	: 215 mm \times 315 mm \times 273 mm
Masse	: 3,5 kg chaque

Présentation et caractéristiques modifiables sans préavis.

AANSLUITINGEN

- Schakel de spanning van alle aangesloten componenten uit alvorens de luidsprekers met de versterker te verbinden.
- De nominale impedantie van de SP-MXJ300, SP-MXJ200 bedraagt 6 Ω .
Kies daarom een versterker waarop u een luidsprekersysteem kunt aansluiten met een impedantie belasting van 6 Ω .
- Het maximum verwerkingsvermogen van de SP-MXJ300 is 100 W en van de SP-MXJ200, 60 W. Te hoge ingang kan in abnormale geluidsreproductie en in beschadigingen resulteren. Overbelasting en verbranding van de bedrading kan worden veroorzaakt wanneer de hieronder beschreven signalen naar de luidsprekers worden gevoed, zelfs wanneer de signalen onder het maximaal toegestane ingangsvermogen zijn. Verminder eerst het volume van de versterker.
 - 1) Ruis, zoals dit optreedt tijdens afstemming op een FM-zender.
 - 2) Hoogfrequentie signalen van een hoog niveau, zoals die tijdens het vooruitspoelen van een tapedeck worden geproduceerd.
 - 3) Klikkende geluiden, die worden veroorzaakt door het in- en uitschakelen van de netspanning van andere componenten.
 - 4) Klikkende geluiden, zoals die worden geproduceerd bij het tot stand brengen of verbreken van aansluitingen terwijl de netspanning is ingeschakeld.
 - 5) Klikkende geluiden, zoals die optreden bij het vervangen van het element van een draaitafel terwijl de netspanning is ingeschakeld.
 - 6) Klikkende geluiden, zoals die worden geproduceerd door bediening van de schakelaars van de versterker.
 - 7) Voortdurende hoogfrequentie-oscillatie, of hoogtonige, elektronisch geproduceerde geluiden van muziekinstrumenten.
 - 8) Rondzingend geluid bij gebruik van microfoons.

TECHNISCHE GEGEVENS

Type	: 2 tweeweg luidsprekers 2 bass reflex
Luidsprekers	: Dual Duct System
Woofer	: 16 cm - kegeltipe \times 1
Tweeter	: 4 cm - kegeltipe \times 1
Toegestane vermogenverwerking	
SP-MXJ300	: 100 W
SP-MXJ200	: 60 W
Impedantie	: 6 Ω
Frequentie karakteristiek	: 45 Hz - 22 000 Hz
Geluidsdrumniveau	: 88 dB/W·m
Afmetingen (B \times H \times D)	: 215 mm \times 315 mm \times 273 mm
Gewicht	: Elk 3,5 kg

Veranderingen in technische gegevens en ontwerp onder voorbehoud.

CONEXIÓN

- Desactive la alimentación de todo el sistema antes de conectar los altavoces al amplificador.
- La impedancia nominal del SP-MXJ300, SP-MXJ200 es de 6 Ω . Seleccione un amplificador al que puedan conectarse altavoces con una impedancia de carga de 6 Ω .
- La potencia máxima admisible del SP-MXJ es de 100 W y la del SP-MXJ200 es de 60 W.
Uná entrada excesiva resultará en ruido anormal y posibles daños.
En casos donde las señales descritas más abajo se apliquen a los altavoces, aunque las mismas resulten menores que la entrada máxima permisible, pueden causar una sobrecarga y quemar el cableado de los altavoces. Asegúrese de disminuir el volumen del amplificador con anterioridad.
 - 1) Ruido durante la sintonía en FM.
 - 2) Señales de alto nivel que contengan componentes de alta frecuencia producidos por un magnetófono en el modo de avance rápido.
 - 3) Ruidos de conmutación provocados al encender y apagar otros componentes.
 - 4) Ruido de conmutación al conectar o desconectar cables con los componentes encendidos.
 - 5) Ruido de conmutación cuando se reemplaza la cápsula con los componentes encendidos.
 - 6) Ruido de conmutación provocados por la operación de los selectores del amplificador.
 - 7) Continua oscilación de alta frecuencia o de sonidos de tonos altos provocados por instrumentos electrónicos.
 - 8) Aullidos al utilizar micrófonos.

ESPECIFICACIONES

Tipo	: Reflex bajo con 2-altavoces y 2 vías
Unidades de altavoces	: Dual Duct System
De graves	: Tipo cónico de 16 cm \times 1
De agudos	: Tipo cónico de 4 cm \times 1
Potencia máxima	
SP-MXJ300	: 100 W
SP-MXJ200	: 60 W
Impédance	: 6 Ω
Gama de frecuencias	: 45 Hz - 22 000 Hz
Nivel de presión sonora	: 88 dB/W·m
Dimensiones (An \times Al \times Pr)	: 215 mm \times 315 mm \times 273 mm
Peso	: 3,5 kg cada uno

El diseño y las especificaciones están sujetos a cambio sin aviso.

COLLEGAMENTO

- Spegnete la corrente dell'intero sistema prima di collegare gli altoparlanti all'amplificatore.
- L'impedenza nominale del modello SP-MXJ300, SP-MXJ200 è 6 Ω.

Selezionate per l'uso un amplificatore a cui collegare un altoparlante con un'impedenza di carico di 6 Ω.

- La potenza massima tollerabile dal modello SP-MXJ300 è 100 W; la stessa, per il modello SP-MXJ200, è 60 W. Un ingresso eccessivo causerà un suono anormale e possibili danni.

Nel caso in cui i segnali descritti qui sotto vengono applicati agli altoparlanti, possono causare un sovraccarico e bruciare il cablaggio degli altoparlanti, anche se i segnali siano al di sotto dell'ingresso massimo ammesso.

Assicuratevi di diminuire il livello del volume dell'altoparlante prima di procedere.

- 1) Generazione di rumore durante la sintonizzazione FM.
- 2) Segnali di alto livello che contengono dei componenti ad alta frequenza riprodotti da una piastra a cassette nel modo di avanzamento rapido.
- 3) Si sentirà uno scatto quando accendete o spegnete la corrente degli altri componenti.
- 4) Si sentirà uno scatto quando collegate o scollegate i cavi con la corrente accesa.
- 5) Si sentirà uno scatto quando viene sostituita la cartuccia con la corrente accesa.
- 6) Si sentirà uno scatto quando vengono usati gli interruttori dell'amplificatore.
- 7) Oscillazione continua ad alta frequenza o suoni acuti da strumenti musicali elettronici.
- 8) Ululato quando usate i microfoni.

SPECIFICAZIONI

Tipo	: Reflex basso con 2-altoparlanti e 2 vie
Le unità altoparlante	: Dual Duct System
Woofer	: Cono da 16 cm × 1
Tweeter	: Cono da 4 cm × 1
Capacità di potenza	
SP-MXJ300	: 100 W
SP-MXJ200	: 60 W
Impedenza	: 6 Ω
Gamma di frequenza	: Da 45 Hz a 22 000 Hz
Livello della pressione sonora	: 88 dB/W·m
Dimensioni : (L × A × P)	: 215 mm × 315 mm × 273 mm
Massa	: 3,5 kg. ciascuno

Il disegno e le specifiche sono soggetti a cambiamenti senza preavviso.

ANSLUTNING

- Slå av strömmen i alla apparater i ljudanläggningen innan högtalarna ansluts till förstärkaren.
- Nominell impedans för SP-MXJ300, SP-MXJ200 är 6 Ω. Se till att använda en förstärkare till vilken högtalare med en belastnings impedans på 6 Ω kan anslutas.
- Maximal effekthanteringskapacitet är 100 W för SP-MXJ300 och 60 W för SP-MXJ200. Brus uppstår i ljudet och högtalarna kan skadas om de matas med för hög effekt. I situationerna som beskrivs nedan kan högtalarna också överbelastas och kabeltråden inne i högtalarna brännas sönder, fastän högtalarnas effekt inte har överskridits.
Sänk därför ljudstyrkan på förhand.
 - 1) Brus under inställning av FM-radiostationer.
 - 2) Starka, högfrekventa signaler från ett kassettdäck under snabbspolning framåt.
 - 3) Ljudbangar som uppstår när andra apparater i anläggningen slås till och från.
 - 4) Skrapljud som uppstår när anslutningskablar ansluts eller kopplas från medan strömmen är på.
 - 5) Skrapljud som uppstår när pickupelementet på en skivspelare byts medan strömmen är på.
 - 6) Ljudbangar som uppstår när du använder förstärkarens omkopplare.
 - 7) Kontinuerliga, högfrekvenssvängningar eller högfrekvent ljud från elektroniska musikinstrument.
 - 8) Akustisk återkoppling (tjutande ljud) vid bruk av mikrofoner.

TEKNISKA DATA

Typ	: 2-vägs, 2-elements basreflexhögtalare
Högtalarelement	: Dual Duct System
Bas	: 16 cm kon × 1
Diskant	: 4 cm kon × 1
Effekthanteringskapacitet	
SP-MXJ300	: 100 W
SP-MXJ200	: 60 W
Impedans	: 6 Ω
Frekvensåtergivning	: 45 Hz - 22 000 Hz
Ljudtrycksnivå	: 88 dB/W·m
Ytermått (B × H × D)	: 215 mm × 315 mm × 273 mm
Vikt	: 3,5 kg per st.

Rätt till ändringar av utförande och specifikationer förbehålles utan föregående meddelande.

TILSLUTNING

- Sluk for strømmen til hele systemet før højttalerne forbindes til forstærkeren.
- Den nominelle impedans for SP-MXJ300, SP-MXJ200 er 6 Ω. Anvend en forstærker, hvortil der kan tilsluttes et højttalersystem med en belastningsimpedans på 6Ω.
- Den maksimale belastningskapacitet for SP-MXJ300 er 100 W og for SP-MXJ200 er den 60 W.

For kraftigt indgangssignal vil resultere i unormal støj og muligvis beskadigelse.

I tilfælde hvor højttalerne udsættes for signaler beskrevet nedenfor, kan der forekomme overbelastning og overbrænding af ledningerne i højttalerne selv om signalstyrken er under den maksimale tilladte værdi. Husk derfor at sænke højttalerlydstyrken i forvejen.

- 1) Støj under FM-afstemning.
- 2) Signaler med høje niveauer der indeholder højfrekvente komponenter dannet af en båndoptager der er indstillet til hurtigt fremspoling.
- 3) Klikstøj dannet når der tændes eller slukkes for strømmen til andre komponenter.
- 4) Klikstøj der dannes når ledninger tilsluttes eller tages ud af forbindelse mens der er tændt for strømmen.
- 5) Klikstøj der dannes når pickuppen udskiftes mens der er tændt for strømmen.
- 6) Klikstøj der dannes når forstærkerens omskiftere betjenes.
- 7) Fortsat høj frekvenssvingning, eller en højlyd dannet af et elektronisk instrument.
- 8) Hyletoner når der anvendes en mikrofon.

SPECIFIKATIONER

Type	: 2-vejs basrefleks-højttaler med 2-elementer
Højttalerenheder	: Dual Duct System
Bashøjttaler	: 16 cm membran × 1
Diskanthøjttaler	: 4 cm membran × 1
Belastningskapacitet	
SP-MXJ300	: 100 W
SP-MXJ200	: 60 W
Impedans	: 6 Ω
Frekvensområde	: 45 Hz - 22 000 Hz
Lydtryksniveau	: 88 dB/W·m
Mål (B × H × D)	: 215 mm × 315 mm × 273 mm
Vægt	: 3,5 kg hver

Design og specifikationer kan blive ændret uden varsel.

LIITÄNTÄ

- Katkaise koko järjestelmän virta ennen kuin suoritat liitännät kaiuttimista vahvistimeen.
- Mallin SP-MXJ300, SP-MXJ200 nimellinen impedanssi on 6 Ω. Valitse käytettäväksi vahvistin, johon voidaan liittää 6 Ω kuormitusimpedanssin omaavat kaiuttimet.
- Mallin SP-MXJ300 suurin tehonkäsittelykyky on 100 W ja mallin SP-MXJ200 60W. Liiallinen antoteho aiheuttaa epänormaalia kohinaa ja jopa vahinkoa.
Tapauksissa, missä kaiuttimet joutuvat alla kuvattujen signaalien kohteeksi, vaikka signaalit olisivat alle sallitun maksimi antotehon, ne saattavat aiheuttaa ylikuormitusta ja polttaa kaiuttimien johdot.
Vähennä siis vahvistimen äänenvoimakkuutta jo ennalta.
 - 1) Kohinaa FM-virityksen aikana.
 - 2) Kasettidekistä eteenpäinkelauksen aikana muodostuneet vahvat, korkeataajuuksisia komponentteja sisältävät signaalit.
 - 3) Klik-ääni, joka syntyy silloin kun toisten osien virta kytketään ja katkaistaan.
 - 4) Klik-ääni, joka syntyy silloin kun kytketään tai irrotetaan johtoja virran ollessa päällä.
 - 5) Klik-ääni, joka syntyy silloin kun vaihdetaan hylsy virran ollessa päällä.
 - 6) Klik-ääni, joka syntyy silloin kun käytetään vahvistimen kytkimiä.
 - 7) Jatkuva korkea värähtely tai elektronisesti tuotettu korkea soittimen ääni.
 - 8) Ulinaa mikrofonia käytettäessä.

TEKNISET TIEDOT

Tyyppi	: 2-tie, 2 kolmen kaiuttimen bassorefleksi
Kaiutinyksiköt	: Dual Duct System
Basso	: 16 cm kartiomuotoinen × 1
Diskantti	: 4 cm kartiomuotoinen × 1
Enimmäisteho	
SP-MXJ300	: 100 W
SP-MXJ200	: 60 W
Impedanssi	: 6 Ω
Taajuusalue	: 45 Hz - 22 000 Hz
Äänenpainetaso	: 88 dB/W·m
Mitat (L × K × S)	: 215 mm × 315 mm × 273 mm
Paino	: 3,5 kg / kaiutin

Oikeudet muutoksiin pidätetään.

PODŁĄCZENIE

- Przed podłączeniem kolumn do wzmacniacza najpierw wyłączyć sieć całego zestawu.
- Impedancja znamionowa kolumn zestawu głośnikowego SP-MXJ300, SP-MXJ200 wynosi 6 Ω.

Wybrać taki wzmacniacz, który pozwala na podłączenie kolumn o impedancji obciążeniowej wynoszącej 6 Ω.

- Maksymalna moc kolumn zestawu głośnikowego SP-MXJ300 wynosi 100W, a zestawu głośnikowego SP-MXJ200 wynosi 60W. Zbyt wysoki poziom sygnału na wejściu kolumn powoduje zniekształcenie dźwięku, a nawet może spowodować uszkodzenie głośników. W przypadku poddania głośników sygnałom wyszczególnionym poniżej może nastąpić przeciążenie głośników oraz przepalenie przewodów głośników nawet, jeżeli sygnały te są poniżej maksymalnego dopuszczalnego poziomu. Pamiętać zawsze o uprzednim zmniejszeniu poziomu głośności wzmacniacza.

- 1) Szumy w czasie dostrajania pasma FM.
- 2) Sygnały o wysokim poziomie charakteryzujące się wysokimi częstotliwościami wytworzonymi przez magnetofon kasetowy w czasie przewijania taśmy do przodu.
- 3) Trzaski pojawiające się w czasie włączania i wyłączenia sieci innych elementów zestawu.
- 4) Trzaski pojawiające się w czasie podłączania lub odłączania przewodów, kiedy sieć jest włączona.
- 5) Trzaski pojawiające się w czasie wymiany wkładki gramofonowej, kiedy sieć jest włączona.
- 6) Trzaski pojawiające się w czasie przełączania włączonego wzmacniacza.
- 7) Długotrwałe oscylujące wysokie częstotliwości lub inne dźwięki wysokiej częstotliwości elektronicznie syntezowane przez instrument muzyczny.
- 8) Gwizdy w czasie używania mikrofonu.

DANE TECHNICZNE

Typ	: Dwudrożny dwugłośnikowy z bass-reflexem
Kolumny głośnikowe	: Dual Duct System
Niskotonowy	: stożkowy, 16 cm śr. × 1
Wysokotonowy	: stożkowy, 4 cm śr. × 1
Moc max	
SP-MXJ300	: 100 W
SP-MXJ200	: 60 W
Impedancja	: 6 Ω
Zakres częstotliwości	: 45 Hz - 22 000 Hz
Poziom ciśnienia akustycznego	: 88 dB/W·m
Wymiary (szer. × wys. × głęb.):	215 mm × 315 mm × 273 mm
Masa	: 3,5 kg każdy

Wygląd zewnętrzny oraz dane techniczne urządzenia mogą ulec zmianie bez uprzedzenia.

CSATLAKOZTATÁS

- Mielőtt a rendszert csatlakoztatná az erősítőhöz, kapcsoljon ki minden berendezést.
- Az SP-MXJ300, SP-MXJ200 rendszer névleges impedanciája 6 Ω.

Olyan erősítőt válasszon, amelyhez 6 Ω terhelő impedanciával rendelkező hangszóró rendszer csatlakoztatható.

- Az SP-MXJ300, SP-MXJ200 rendszer maximális bemenő teljesítménye 60 W. Nagy energiájú bemeneti jel rendellenes zajt generálhat és a rendszer károsodását okozhatja. Az alább leírt jelek még a maximális megengedett bemeneti szint alatt is a rendszer túlterhelését és a hangszóró tekercsek leégését okozhatják.

- 1) FM (URH) hangolás alatti zaj.
- 2) A magnódeck gyors előretekerésénél keletkező, magas frekvenciájú komponenseket tartalmazó intenzív jelek.
- 3) Egyéb berendezés be és kikapcsolásakor keletkező kattánójaj.
- 4) Bekapcsolt üzemállapotban a tápkábel össze és szétcsatlakoztatásakor keletkező kattánójaj.
- 5) Bekapcsolt üzemállapotban történő patroncsere során keletkezőzaj.
- 6) Az erősítő kapcsolóinak használatakor keletkező kattánójaj.
- 7) Elektromos hangszer által keltett folyamatos, magas frekvenciájú rezgésű vagy magas tónusú hang.
- 8) Mikrofon használatakor keletkező fűtőlő zaj.

MŰSZAKI ADATOK

Typus	: 2-utas, 2-hangszórós bassreflex típus
Hangsugárzó egység	: Dual Duct System
Mélysugárzó	: 16 cm, kónuszos, × 1
Magassugárzó	: 4 cm, kónuszos, × 1
Bemenő teljesítmény	
SP-MXJ300	: 100 W
SP-MXJ200	: 60 W
Impedancia	: 6 Ω
Frekvenciatartomány	: 45 Hz - 22 000 Hz
Hangnyomásszint	: 88 dB/W·m
Méreték (szélesség × magasság × mélység)	: 215 mm × 315 mm × 273 mm
Tömeg	: 3,5 kg/darab

A formaterv és a műszaki adatok változtatásának joga – minden külön értesítés nélkül – fenntartva.

ZAPOJENÍ

- Vypojte napájení celé soustavy před zapojením reproduktorů k zesilovači.
- Jmenovitá impedance SP-MXJ300, SP-MXJ200 je 6 Ω.
Zvolte si k používání zesilovač, k němuž je možné zapojit reproduktorovou soustavu s impedancí zátěže 6 Ω.
- Maximální kapacita příkonu, který může zpracovat SP-MXJ300 je 100W a SP-MXJ200 je 60 W. Nadměrný příkon způsobí abnormální hluk a možné poškození. V případech popsaných níže a to i tehdy, jsou-li signály pod úrovní maximálního možného příkonu, může dojít k přetížení a ke spálení vinutí reproduktorů. Dbejte na snížení výkonu zesilovače předem.
 - 1) Šum během FM ladění.
 - 2) Signály vysoké úrovně obsahující vysokofrekvenční komponenty vytvořené magnetofonem při rychlém převíjení vpřed.
 - 3) Zvuk lupnutí vytvořený během zapínání a vypínání ostatních komponentů.
 - 4) Zvuk lupnutí vytvořený během zapojování nebo rozpojování šňůr na zapnutém přístroji.
 - 5) Zvuk lupnutí vytvořený při výměně zásobníku na zapnutém přístroji.
 - 6) Zvuk lupnutí vytvořený při obsluze přepínačů zesilovače.
 - 7) Spojitý vysokofrekvenční oscilační nebo vysokotónový zvuk elektronicky vytvořený hudebním nástrojem.
 - 8) Houkání při použití mikrofonů.

TECHNICKÁ SPECIFIKACE

Typ	: 2-pásmový 2-reproduktorový basreflexový typ
Reproduktorové soustavy	: Dual Duct System
Hlubkový	: 16 cm kuželový × 1
Výškový	: 4 cm kuželový × 1
Kapacita zpracovatelného příkonu	
SP-MXJ300	: 100 W
SP-MXJ200	: 60 W
Impedance	: 6 Ω
Frekvenční rozsah	: 45 Hz - 22 000 Hz
Hladina zvukového tlaku	: 88 dB/W·m
Rozměry (Š × V × H)	: 215 mm × 315 mm × 273 mm
Hmotnost	: 3,5 kg každý

Vzhled a specifikace podléhají změnám bez předchozího upozornění.

JVC
VICTOR COMPANY OF JAPAN, LIMITED